



ZEISS 2022 / 2023
Hunting and Precision Shooting Catalog

www.zeiss.com/hunting



Seeing beyond

ON THE HUNT WITH ZEISS. AT ONE WITH THE WILDERNESS.

People go hunting because they love nature. But loving nature also means braving the wilderness and the elements. Enduring the cold, the heat, and rough terrain. This is the only way to really gaze into nature's soul.

This requires companions that are capable of withstanding these harsh conditions. That you can rely on in any situation. Tailored to each individual's needs, they must be a match for the wilderness and deliver top performance, even in the most demanding situations. These are the qualities that the ZEISS brand stands for.

ZEISS binoculars, riflescopes, thermal imaging devices, and spotting scopes have an excellent reputation among hunters around the world – they not only guarantee hunting success, but also unforgettable hunting moments.

Enjoy your very own special moments with ZEISS – we wish you every success on your hunt.

Detailed information about our products can be found on our website at www.zeiss.com/hunting



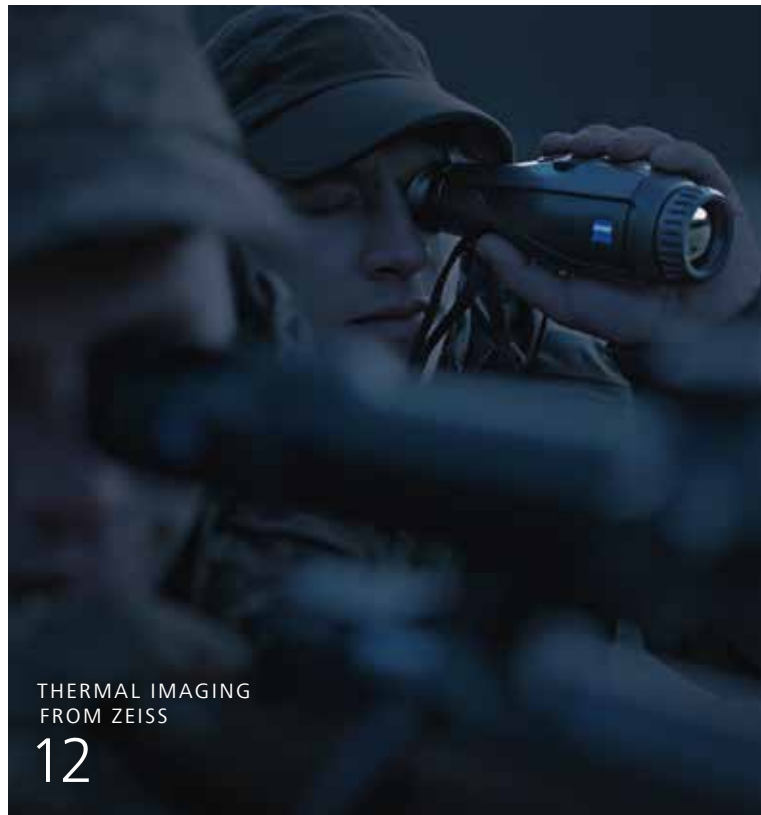

Proven in the lab, tried and tested in the great outdoors 6

Hunting App 8

Thermal Imaging at a glance 30

Riflescopes at a glance 58

Recticles from ZEISS 60

Binoculars at a glance 112

ZEISS Hunting Community 128

THERMAL IMAGING 12

DTC 3 16

DTI 3 24

RIFLESCOPES 32

ZEISS V8 34

Victory HT 40

Conquest V6 46

Conquest V4 52

LRP S5 64

BINOCULARS 72

Victory SF 74

Victory SFL 80

Victory HT 86

Victory Pocket 92

Conquest HD 96

Terra ED 102

Victory Rangefinder System 108

SPOTTING SCOPES 114

Victory Harpia 116

Conquest Gavia 120

Dialyt 124

SPECIALS 126

Victory Night Vision 126

Monos /20x60 S 127

Tailored to your needs – ZEISS always offers the ideal product for the highest personal standards and a variety of hunting challenges. Uncompromising design, ergonomics, and optics, yet simple and rugged in use – that is what ZEISS riflescopes, binoculars, spotting scopes, and thermal imaging cameras are all about.

PROVEN IN THE LAB. TRIED AND TESTED IN THE GREAT OUTDOORS.



Testing extreme situations: significant temperature fluctuations within minutes and shot simulations with 1,500 times the force of gravity.

No holds barred: ZEISS quality not only holds its own in the lab, but also in the harsh everyday hunting environment.

For over 175 years, ZEISS has been developing premium optical devices that stand out for their optical clarity, technical innovations, and outstanding ergonomics.

end to a day's hunting. That is why absolute reliability – even under the most adverse conditions – is our top priority.

The ability of your optical devices to withstand the rain should be the least of your worries at this point. Similarly, it is virtually impossible to avoid extreme temperature fluctuations when stepping out of your heated car into the cold winter air.

But it is not just this pursuit of perfection that makes ZEISS optics what they are. Hunting optics are not scientific instruments, but tools that have to work at all times, even in the toughest hunting conditions.

Defy the elements.

Thanks to the best materials and uncompromising manufacturing quality, we can guarantee a level of reliability and ruggedness that is appreciated by hunters the world over. Hunters and their gear have to brave inclement weather and difficult terrain again and again. If heavy rain sets in when hunting from a raised hide, there is usually only one thing to do: hang in there!

But it isn't only environmental factors that play a role. A fall in difficult terrain with a shouldered weapon, your weapon falling over when in a raised hide, or a bumpy ride in the trunk – in these situations, the ability of your optical devices to take a beating is of paramount importance.

A material defect in your jacket or hiking boots that aren't waterproof are annoying. But a malfunctioning gun or optical device means an abrupt

Your ZEISS optical device is ready for anything.

This is why every ZEISS optical device is subjected to elaborate tests at our in-house ZEISS test lab to determine its durability and suitability for everyday use. In this process, our proven testing procedures push the devices to their limits. In this context, ZEISS utilizes a range of special testing methods. Whether simulating transport, continuous shock, firing with 1,500 times the force of gravity, the 24-hour corrosion test in aggressive salt spray, or testing the product's waterproofness by submerging it in water, all of the

tests simulate levels of stress many times higher than those encountered in normal hunting use. These rigorous testing procedures ensure that every device functions flawlessly in the harsh day-to-day hunting environment, allowing you to perform with absolute confidence at the decisive moment – for years and decades to come.

No punches pulled



Experience ZEISS optical devices in a stress test – under both extreme conditions in the lab and in harsh real-world conditions.

www.youtube.com/user/zeissportsoptics



THE APP FOR THE MODERN HUNTER.

ZEISS Hunting App – ballistics. Hunting ground management. Hunting diary.

A versatile hunting companion – the ZEISS Hunting App is available to hunters as both a mobile app and as a web app on desktops and tablets. In addition to numerous helpful features to prepare for and document a hunt, it now also offers the ability to manage hunting grounds together with others. This makes organization and communication in the hunting ground even easier. You can also share diary entries, ballistic profiles, and gear data with friends right in the app.

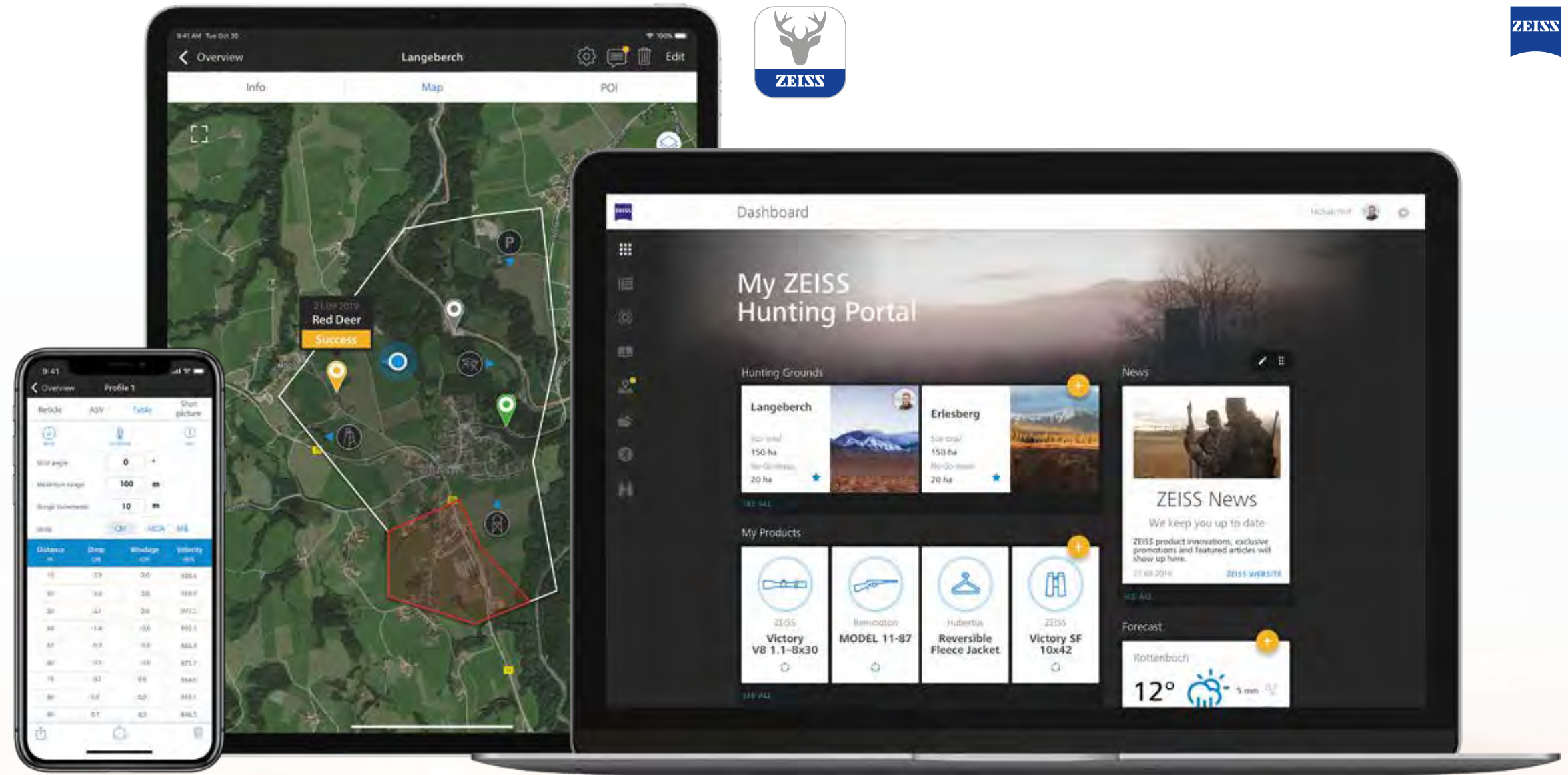

Dashboard

A customizable home screen with direct access to your favorite features.

Ballistic

Ballistic calculations and ballistic reticle/ASV including an ammunition database with over 7,000 entries matched to your specific riflescope.

Hunting diary

Document all of your experiences with hunting-related data such as information about the game and your shots, photos, videos, and much more.

Hunting grounds

Create and manage hunting grounds in the app or via browser. You can easily mark important points on the map. The app displays your current position to help you to find your way around the area. You can manage hunting grounds together with your fellow hunters, with whom you can communicate via the hunting ground pinboard.

Weather information

A weather forecast specifically tailored to your needs, with information about your current location and preferred hunting grounds.

My gear

A convenient overview of all your hunting gear. Important product information at your fingertips and all in one place.

Connected products

Connect and configure the ZEISS Victory Rangefinder and ZEISS DTC 3 thermal imaging clip-ons via Bluetooth and the ZEISS DTI 3 thermal imaging cameras via WLAN.

News

All of your shared posts are displayed together in a news feed, along with exclusive offers and ZEISS product news.

Sharing

Share your entries from the Ballistics, Hunting Diary, and My Gear sections with your friends right from the app.

The ZEISS Hunting App is available free of charge. Download it from the Apple App Store or the Google Play Store. The browser version is available at hunting.zeiss.com



For more details, visit www.zeiss.com/hunting/app

CONNECTED PRODUCTS – DEVICES CONNECTED TO THE ZEISS HUNTING APP.

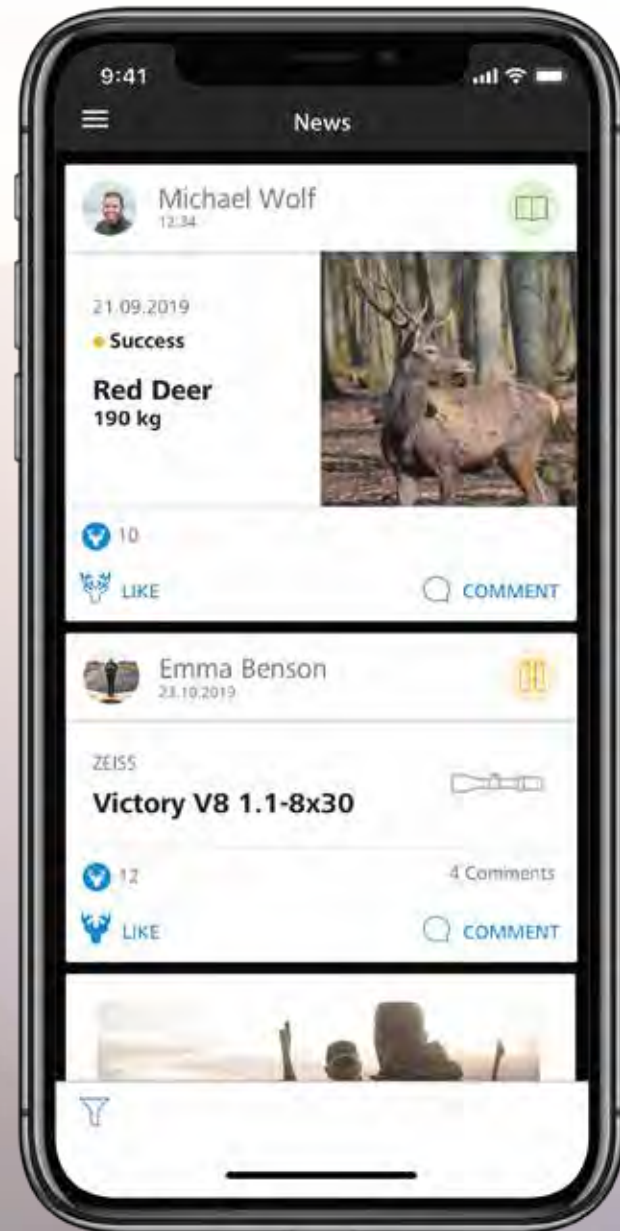

ZEISS VICTORY RF

Laser rangefinder with integrated real-time ballistic calculator

Space to save up to nine personalized ballistic profiles that can be set up in the ZEISS Hunting app. Thanks to Bluetooth connectivity, you can import personal ballistics data from the ZEISS Hunting App into the Victory RF. Each measurement also takes the physical properties and environmental factors such as temperature and air pressure into account in the calculation.



 Bluetooth

ZEISS DTI 3

Thermal imaging camera

Using the ZEISS Hunting app, hunters can copy data from the thermal imaging camera directly to a smartphone via WLAN and even live-stream their hunting adventures.



ZEISS DTC 3

Thermal imaging clip-on

ZEISS DTC 3 thermal imaging clip-ons can also be programmed and customized via the ZEISS Hunting app. In addition, the app offers a digital zeroing assist feature. You can also save up to four personal zeroing profiles here.



 Bluetooth

Ethically hunting wild boar at night requires the right equipment. After all, in the dark it is almost impossible to rely on your sense of sight alone. But the night is precisely the most important time for hunters when hunting sows.

That's why hunters need a companion, one that makes it possible to accurately identify the game, even in the dark. A companion with the highest optical standards that can be relied on at night. A companion in familiar ZEISS quality. This is precisely why ZEISS has developed thermal imaging cameras and now also the first thermal imaging clip-on. These were designed together with hunting experts specifically for night hunting.

Further information is available on our website at www.zeiss.com/thermal-imaging



THERMAL IMAGING FROM ZEISS

HANDLE THE NIGHT – WITH THERMAL IMAGING DEVICES.

Thermal imaging devices from ZEISS feature a wide range of advanced technologies and innovations. The following pages explain which products offer which specific features and benefits in detail. Here's an initial overview:

OPTIMAL ERGONOMICS

Excellent handling in the cold and darkness.

PERFECT SIGHT AND OVERVIEW

High-precision detail detection and extremely wide field of view.

PRECISE ZOOM

Fine, gradual adjustment of the zoom in 0.5x increments.

EXTRA LONG BATTERY LIFE

Battery capacity for long sessions with 10 hours of battery life.



HOW THERMAL IMAGING DEVICES WORK.

Thermal imaging devices for hunting applications differ greatly from traditional optical devices for observation, such as binoculars and riflescopes. The optoelectronic devices are more comparable to digital cameras. A thermal imaging camera detects and measures the infrared energy emitted by objects. Using an image processing algorithm, the processor creates a colored representation of the object's temperature based on the signals from the individual pixels. In this context, each temperature value is assigned to a specific color. In addition, thermal imaging photos and videos can be recorded and transmitted via smartphone. Below we explain how they work and their individual components.

Functionality

While the light sensitivity of conventional digital cameras lies in the visible range of the human eye, thermal imaging cameras operate in the long-wave infrared range. This allows them to detect the thermal radiation emitted by a body independent of the available visible light, which is why thermal imaging devices can be used both in daylight and in total darkness.

Lens

The lenses are made of germanium, an element which transmits light in the required wavelength range. Germanium is extremely hard and is therefore always used when particularly robust and resistant optics are required.

High-quality eyepiece

Similar to the lens, the thermal imaging device's eyepiece also features high-quality optics. This allows the relaxed eye focused to infinity to view the image shown on the viewfinder display.

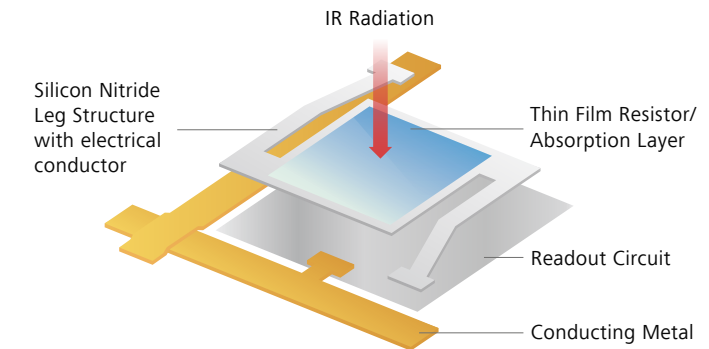
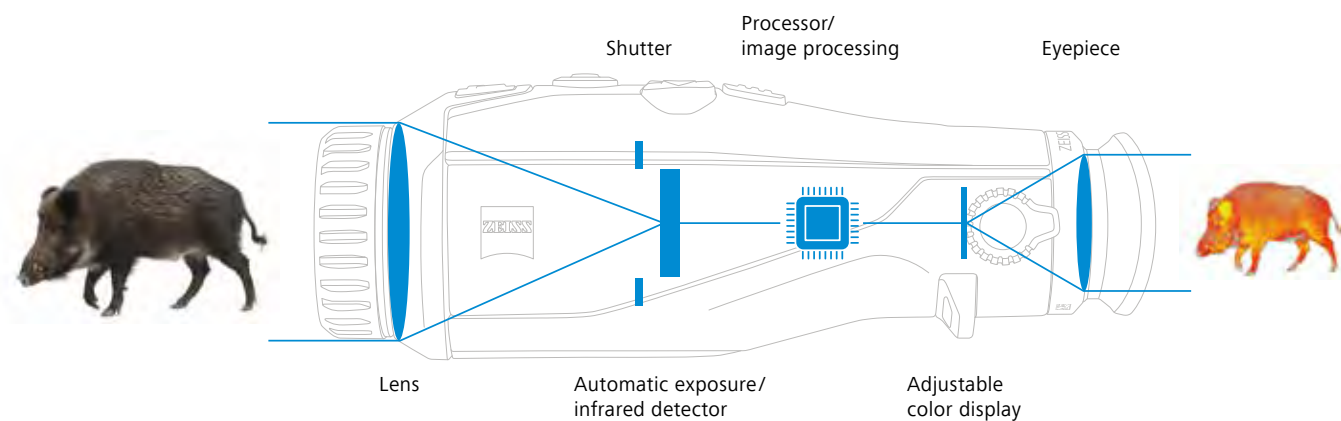

Schematic illustration of a microbolometer.

Sensor

The sensor of a thermal imaging camera is known as a microbolometer. This mainly consists of amorphous silicon (ASI) or vanadium oxide (VOx). The electrical resistance of both materials is highly dependent on the temperature.

Adjustable color display

Depending on the area of application and how clearly the hunter wants to be able to recognize individual details in the subject, as well as their personal taste, different display modes (e.g., White Hot, Black Hot, Red Hot, Rainbow) in shades of gray or color can be selected for the image displayed on the thermal imaging camera's color screen. In addition, the overall brightness of the display can be varied to adjust it in order to suit eyes adapted to either light or dark.

Image processing

The electronic signal coming from the sensor is first digitized and then optimized via a complex image processing algorithm and adapted to the respective hunting situation. The perfect compatibility of the hardware components (lens, sensor, display, eyepiece) with the internal signal processing algorithm ultimately determines the visible image quality and how well relevant details can be recognized during an observation.

Shutter

Just like a digital camera, this can be used to control the amount of radiation passing through the lens. This shutter interrupts the infrared radiation that strikes the detector at regular intervals so that the detector can recalibrate itself from time to time. This produces the quiet clicking sound typical of thermal imaging devices.

Auto exposure system/ infrared detector

A thermal imaging camera is equipped with an "auto exposure" system, so to speak – depending on the ambient conditions, i.e., the changing temperature conditions, the temperature differences across the subject being viewed are divided into brightness or color differences in the best possible way. This produces a bright and high-contrast image for the viewer under all conditions. The resulting image does not reproduce the original colors of the object, but only shows temperature differences. The greater the temperature differences between the observed object and the environment, the more clearly its details and edges can be seen. In this process, the camera's image processing algorithm automatically adjusts the brightness and contrast.



Example of use – observe prohibitions in gun and hunting laws!

ACCURATE. DURING NIGHT HUNTING. INTUITIVE AND CUSTOMIZABLE. ZEISS DTC 3

The ZEISS DTC 3 Thermal Imaging Clip-Ons stand out thanks to their best-in-class optics, outstanding ease of use, and intelligent features – for maximum hunting success at night.

Not only the darkness, but the fog and cold are special challenges hunters regularly face when hunting at night. With the ZEISS DTC (Digital Thermal Clip-On) 3/25 & 3/38, hunters are prepared for any situation, no matter how demanding, and can count on the best optics, a detailed image, intuitive ergonomics, and the greatest possible flexibility – whether in the open field or in the forest.

Sensor-enabled standby mode

Power **Off**

Power **On**

Power **Off**

The angle sensor automatically detects the exact position of the ZEISS DTC 3 and activates standby mode at a lateral angle of 45° and at a downward or upward angle of 70°. When the hunter brings the weapon back to the firing position, the device automatically exits standby mode.

*The picture shows an example of use that, in connection with firearms, is subject to prohibitions and exceptional caveats under gun and hunting laws. Use in connection with firearms is only allowed if you have a gun/hunting permit. The depicted firearm is not included. You must hold a permit to purchase this item.



RELIABILITY AND PRECISION IN THE DARK.

Customizable

The ZEISS DTC 3 can be connected to the ZEISS Hunting App via Bluetooth and then adapted to your own needs and requirements. In addition, you can save up to four profiles for different riflescopes.



Easy to use

Thanks to the central positioning of the focusing turret and the intelligent layout of the buttons, the ErgoControl operating concept offers outstanding ease of use – both for left-handed or right-handed users and when wearing gloves.



10 h
of battery life
in continuous
use!



Always ready

With 10 hours of battery life in continuous use, the ZEISS DTC 3 can be used to observe for particularly long periods. The standby mode activated by the angle sensor additionally extends battery life. The device can even be charged directly in the field via a portable, external power bank.



Fast and precise zeroing

The zeroing assist that can be operated via the ZEISS Hunting App calculates the compensation values after entering the point of impact deviation, realigns the display accordingly and thus automatically centers the reticle. This eliminates the need to calculate clicks and makes the process much faster and hassle-free.



Accurate

Perfectly compatible components and an advanced image processing algorithm enhance night vision for an ethical hunt.



MAXIMUM FLEXIBILITY DURING NIGHT HUNTING WITH THE ZEISS HUNTING APP.

The ZEISS Hunting App offers numerous features, such as the ability to capture, manage, document, and synchronize current happenings and hunting experiences directly from the field. The decisive advantage is that personal settings can also be configured via the app.

Configurable. For personalized hunting experiences.

The ZEISS DTC 3 can be connected to the ZEISS Hunting App via Bluetooth and adapted to your own requirements. One particularly convenient feature is that once the combination of ZEISS DTC 3 and riflescope has been zeroed, the hunter can save the setting as a profile in the app and easily switch the clip-on from one riflescope to the other. The ability to save up to four shooting profiles adds an impressive level of flexibility.



ZEISS HUNTING APP



Save up to four zeroing profiles. Capture and share current happenings and experiences right on the spot. It's all possible with the ZEISS Hunting App! Also available as a browser version.

App Store



Google Play



Download the app for iOS or Android for free today!

*The picture shows an example of use that, in connection with firearms, is subject to prohibitions and exceptional caveats under gun and hunting laws. Use in connection with firearms is only allowed if you have a gun/hunting permit. The depicted firearm is not included. You must hold a permit to purchase this item.



Can be operated via app

The ZEISS DTC 3 can be connected to the ZEISS Hunting App via Bluetooth and then adapted to your own requirements.

For example, hunters can select which icons are displayed on the screen and customize the information presented to suit their needs.

The ZEISS DTC 3's control buttons can also be mirrored onto a smartphone – turning it into a flexible remote control.



ALWAYS READY

THANKS TO A SOPHISTICATED POWER MANAGEMENT.



Example of use – observe prohibitions in gun and hunting laws!*

Every hunter knows that a night hunt can sometimes last a long time. This not only requires patience, but also reliable battery performance. The ZEISS DTC 3 models offer 10 hours of continuous battery life, allowing for virtually unlimited use. In addition, the ZEISS DTC 3 can also be recharged via a portable power bank, if necessary.

Automatic standby mode

The angle sensor automatically detects the exact position of the clip-on and activates standby mode at a lateral angle of 45° and at a downward or upward angle of 70°. When the hunter brings the weapon back to the firing position, the ZEISS DTC 3 automatically exits standby mode. Standby mode can, however, also be deactivated by briefly pressing the power button.

OPTICAL EXPERTISE

Field of view comparison.

The ZEISS DTC 3/38 is optimized for higher magnification levels, as the full field of view can already be used when the riflescope is at 3x optical magnification. Our especially popular 3–12x56 riflescope is one of the models that you can combine with the ZEISS DTC 3/38 to benefit from a full field of view at 3x magnification. Numerous competitors only offer this advantage at lower magnifications.



View through a competing clip-on



View through the ZEISS DTC 3

*The picture shows an example of use that, in connection with firearms, is subject to prohibitions and exceptional caveats under gun and hunting laws. Use in connection with firearms is only allowed if you have a gun/hunting permit. The depicted firearm is not included. You must hold a permit to purchase this item.

CONVENIENT ZEROING

THANKS TO THE DIGITAL ZEROING ASSIST.



Every millimeter is crucial during the hunt, which is why an exact adjustment is so important during the zeroing process. The precise zeroing assist for the ZEISS DTC 3/25 and 3/38 is very easy to operate via the ZEISS Hunting App and thus makes the zeroing process not only faster, but also simpler and more convenient.

The hunter only has to enter the distance and the location of the hit into the app. The assist then independently calculates the corrective values and realigns the display accordingly. This eliminates the need to calculate clicks and makes the process much faster and hassle-free.

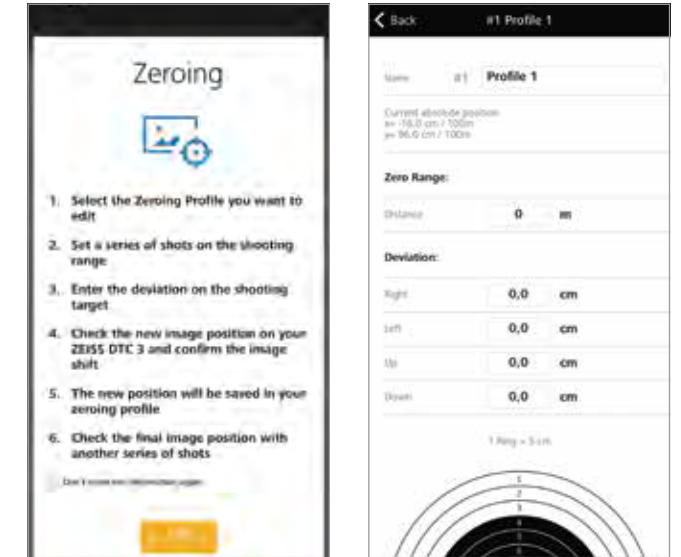

Zeroing via the ZEISS Hunting App

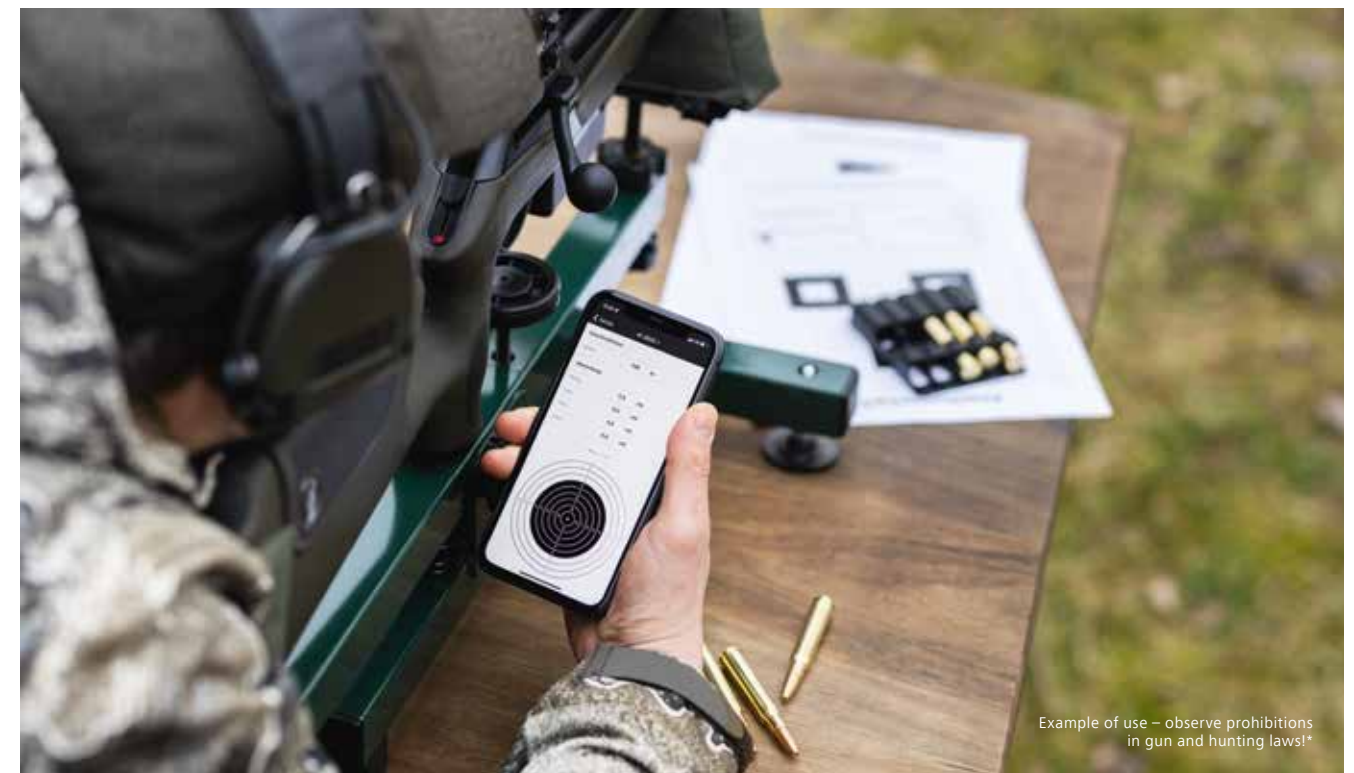

Example of use – observe prohibitions in gun and hunting laws!*

THE ZEISS DTC 3/25 & 3/38 MODELS. COMPARISON OF BENEFITS.



ZEISS DTC 3/25

Particularly in the forest, the ZEISS DTC 3/25 – with its large field of view of 18.4 meters at a distance of 100 meters – offers a crucial overview and the ability to easily recognize details. Due to these outstanding optics, when they spot game hunters are perfectly equipped to react quickly, even at short distances and in total darkness.



ZEISS DTC 3/38

Range and accuracy at long distances play a crucial role in night hunting in open terrain. The ZEISS DTC 3/38 covers a larger area, has a field of view of 12.3 meters at 100 meters, and an accurate click value of 1.6 cm at 100 meters – for extremely precise zeroing and thus highly accurate and ethical shots.

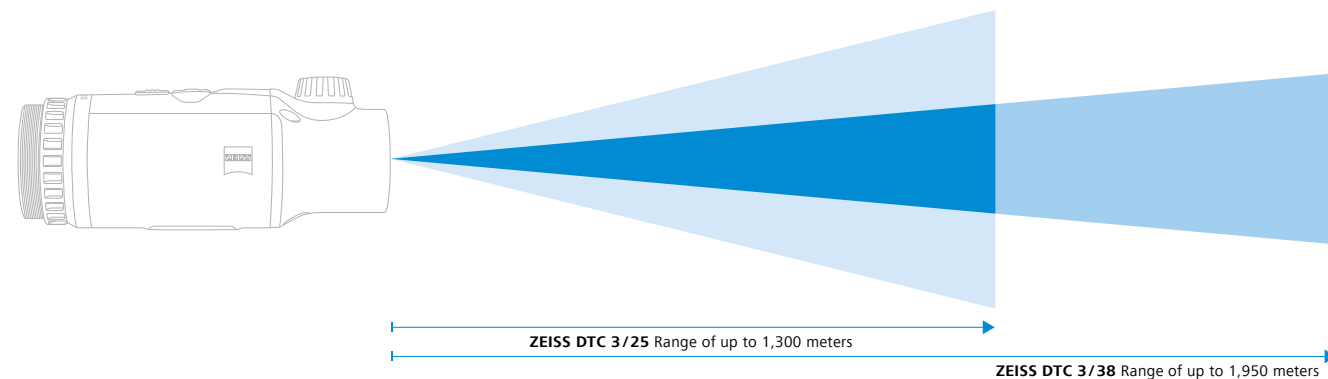

With a field of view of 18.4 meters at 100 meters, the ZEISS DTC 3/25 provides the best overview for night hunting in forested areas.



Thanks to a range of up to 1,950 meters, the ZEISS DTC 3/38 is perfect for identifying game at longer distances.

*The picture shows an example of use that, in connection with firearms, is subject to prohibitions and exceptional caveats under gun and hunting laws. Use in connection with firearms is only allowed if you have a gun/hunting permit. The depicted firearm is not included. You must hold a permit to purchase this item.

TECHNICAL SPECIFICATIONS.

Model	Thermal Imaging Clip-On	
	ZEISS DTC 3/25	ZEISS DTC 3/38
Optics		
Focal length	25 mm / F1.0	38 mm / F1.0
Lens type	Germanium	
Range	~ 1,300 m	~ 1,950 m
Field of view in m at 100 m	18.4 m	12.3 m
Field of view in degrees (horizontal x vertical)	10.5° x 7.9°	7° x 5°
Optical magnification	1x	
Maximum image adjustment X to 100 m	±307 cm	±205 cm
Maximum image adjustment Y to 100 m	±230 cm	±154 cm
Adjustment per click at 100 m	2.4 cm	1.6 cm
Sensor		
Sensor resolution	384 x 288 px	
Sensor pixel pitch	12 µm	
Frame rate	50 Hz	
Display		
Display resolution	1,024 x 768 px	
Display type	AMOLED	
Electronics		
Interfaces	USB: charging Bluetooth: data transfer	
Battery	Lithium-ion	
Battery life	10 h	
External power supply (not included in the package)	5V / 2 A (USB)	
Connection to other devices	ZEISS Hunting App, Bluetooth	
General		
Ingress protection rating	IP65 / IP67 (protection against heavy rain)	
Operating temperature range	-10 °C to +50 °C	
Length x width x height	150 mm x 60 mm x 65 mm	164 mm x 60 mm x 65 mm
Weight	560 g	650 g
Order no.	527030	527031

Subject to changes in design and scope of delivery as a result of ongoing technical development.

ACCESSORIES

ZEISS DTC adapter

ZEISS offers the DTC adapter as an accessory to conveniently mount the clip-on to the riflescope. Once the combination of ZEISS DTC 3 and riflescope has been zeroed in, the ZEISS DTC 3 can be easily switched from one riflescope to the other with the aid of a two-part adapter – without changing the point of impact and having to be zeroed in again.





HANDLE THE NIGHT. INTUITIVE AND ERGONOMIC. ZEISS DTI 3

The ZEISS DTI 3 models – technologically innovative optical devices for the night in familiar ZEISS quality and a one-of-a-kind, ergonomic design.

Hunting at night is a special experience for many hunters – but one that places high demands on the equipment used. With its DTI 3 thermal imaging cameras, ZEISS always offers the right optical devices for nighttime hunting. Designed by hunting experts specifically for hunting, they produce detailed images to accurately identify targets, even in the dark.

ErgoControl Concept

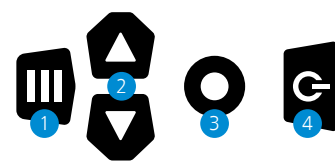

- 1 Menu | Color Modes
- 2 Zoom | Menu Navigation
- 3 Video | Photo
- 4 On/off button

Thanks to the intelligently positioned buttons, all of the functions can be controlled intuitively. The perfectly shaped controls can be quickly identified – even in the dark or when wearing gloves.

PRODUCT PROFILE

DETAILED IMAGES – EVEN IN TOTAL DARKNESS.



Precise zoom

The fine, gradual zoom adjustment in 0.5x increments offers the perfect combination of magnification and detail recognition.



Enhanced camouflage

Thanks to the LED Off feature, the device's status display can be switched off manually, thus preventing the game from noticing the light – whether when stalking or hunting.



With an extra-long 10h of battery life!

Extra long battery life

With an impressively long battery life of 10 hours, the ZEISS DTI 3 holds enough charge for two to four hunts. The standby feature conserves battery power by automatically shutting off the thermal imaging camera after 60 minutes of inactivity.



Outstanding optics in familiar ZEISS quality

The high-resolution 1,280x960 pixel HD-LCOS display delivers detailed images – even in total darkness.



HANDLE THE NIGHT – THANKS TO INTUITIVE ERGNOMICS.

The ZEISS DTI 3 models owe their outstanding optical performance to the fact that the lens, sensor, electronics, screen, and eyepiece are all perfectly compatible. Above all, however, the DTI 3 family of thermal imaging cameras stands out thanks to its unique ergonomics – the ErgoControl operating concept, with its intelligently positioned buttons, makes it easy to intuitively activate all of the device’s functions.

The perfect ergonomic design offers excellent handling in cold and dark conditions and ensures that both right-handed and left-handed users can operate the device comfortably.

Perfect ergonomics

Thanks to the ErgoControl operating concept with its intelligently positioned buttons, all of the functions can be controlled intuitively.



ErgoControl concept for intuitive operation

Contrast enhancement in foggy conditions

The Contrast Boost feature maximizes contrast to see as much detail as possible, even in foggy or humid conditions.



Contrast Boost Off



Contrast Boost On



Picture-in-picture mode

Improved focusing

In picture-in-picture mode, a focus frame highlights the enlarged image section. For improved focusing and a successful, ethical hunt.

Areas of expertise combined

During the development of the DTI 3 models, which are the first thermal imaging devices from ZEISS, the company brought two different areas of expertise together. This is because only ZEISS’ more than 130 years of experience in the fields of hunting and photography have made it possible to develop thermal imaging optics that stand out not only for their outstanding image quality, but also for their unique, intuitive ergonomics that maximize hunting success.

Learn more at www.zeiss.com/nighthunting

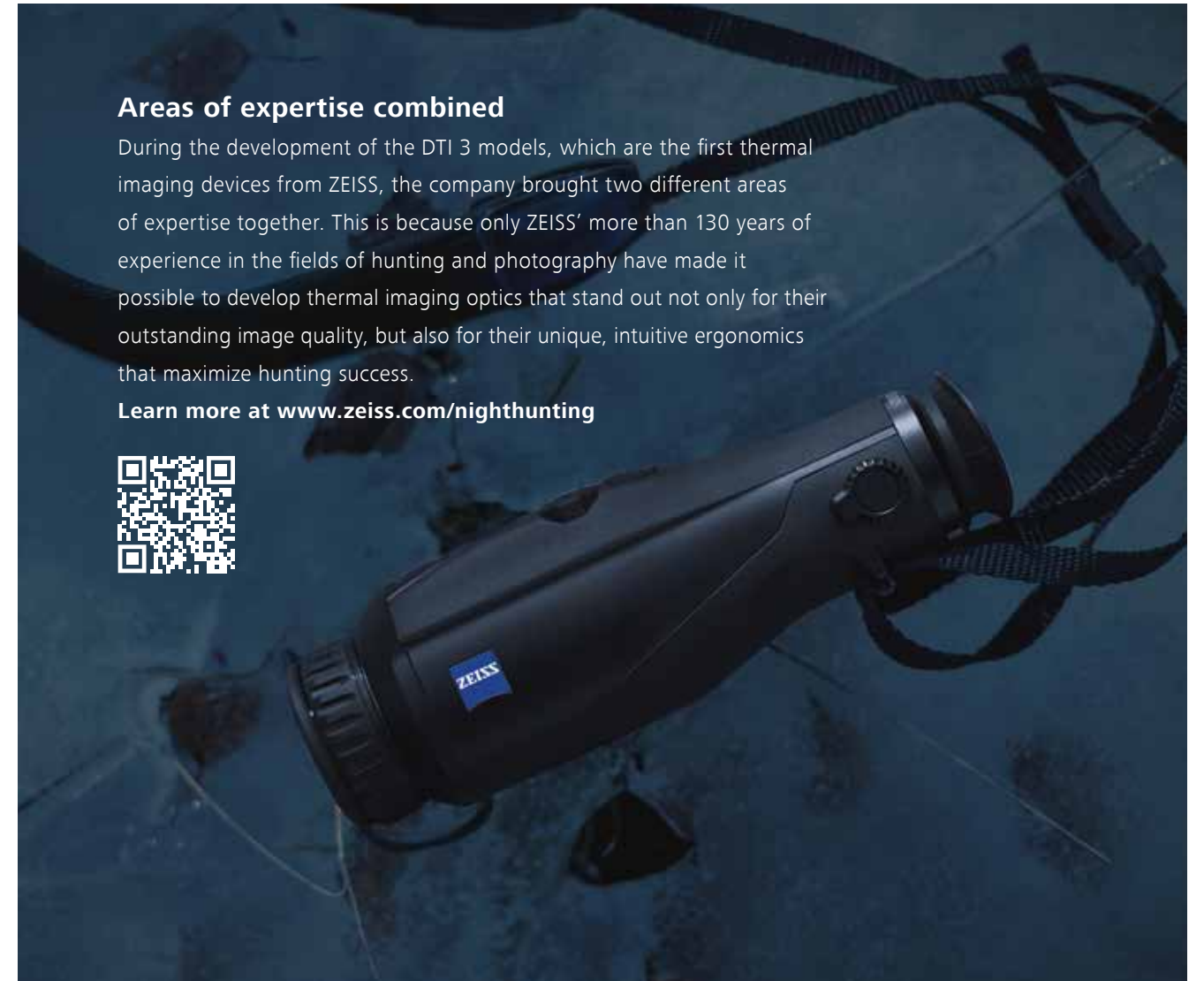

STAY CONNECTED – WITH THE ZEISS HUNTING APP



Depending on the thermal imaging clip-on, the ZEISS Hunting App offers a variety of benefits and features. The ZEISS DTI 3 models let you manage and share photos and videos via the app and watch livestreamed hunting experiences. The ZEISS DTC 3 thermal imaging clip-ons can also be programmed and customized via the app. You can save up to four personal profiles here. In addition, the app offers a digital zeroing assist feature.

To learn more, visit zeiss.com/hunting/app
The browser version is available at hunting.zeiss.com

VIEW THE NIGHT IN DETAIL. ZEISS DTI 3/35 & DTI 3/25.



ZEISS DTI 3/25

Whether in wooded areas or at the bait site – this high-quality thermal imaging system offers a wide field of view of 26 meters at a range of 100 meters. Thanks to its outstanding optics, the ZEISS DTI 3/25 thus provides a perfect overview that reliably detects heat sources, especially at short distances.



The ZEISS DTI 3/25 offers an extremely wide field of view of 26 meters at 100 meters, making it ideal for hunting in wooded areas or at the bait site.



ZEISS DTI 3/35

Whether for observing and tracking or to more quickly and accurately identify game, this high-quality thermal imaging system ensures that hunters can precisely recognize details even at distances of more than 1,200 meters. As a result, the ZEISS DTI 3/35 gives hunters a considerable advantage when stalking at night or when hunting over long distances from a raised hide in a field.



Thanks to a range of up to 1,200 meters, the ZEISS DTI 3/35 is ideal for hunting from a raised hide in a field over long distances.

HOW TO USE ALL THE FEATURES OF THE ZEISS HUNTING APP



Share your hunting successes, document your hunting experiences, manage your hunting equipment, create ballistic profiles, and much more. The ZEISS Hunting App can be easily connected to all ZEISS thermal imaging clip-ons via WLAN (or Bluetooth, depending on the model).

Video tutorials showing how to use all the features of the ZEISS Hunting App can be found on YouTube:



TECHNICAL SPECIFICATIONS.

Model	Thermal Imaging Camera	
	ZEISS DTI 3/35	ZEISS DTI 3/25
Optics		
Focal length	35 mm / F1.0	25 mm / F1.0
Lens type	Germanium	
Range	~ 1,235 m	~ 880 m
Eyepiece field of view in ° (subjective field of view)	Diagonal: 30.25°	Diagonal: 30.25°
Lens field of view in m at 100 m	Horizontal: 19 m	Horizontal: 26 m
Lens side field of view in ° (horizontal x vertical)	10.7° x 8°	15° x 11°
Optical magnification	2.5 x	1.8 x
Maximum digital zoom	4 x	
Zoom increments	In 0.5 x increments from 1.0 x – 4.0 x	
Sensor		
Sensor resolution	384 x 288 px	
Sensor pixel pitch	17 µm	
Frame rate	50 Hz	
Display		
Display resolution	1,280 x 960 px	
Display type	LCOS	
Electronics		
Interfaces	USB: charging + data transfer WLAN: data transfer	
Battery	Lithium-ion	
Battery life	10 h	
External power supply	5V/3A, 9V/2A, 12V/1.5A (USB)	
Internal memory	15 GB	
Video/photo/livestreaming feature	yes	
WLAN frequency	2.4 Ghz	
WLAN standard	IEEE 802.11 b/g/n	
Connection to other devices	ZEISS Hunting App/USB	
General		
Ingress protection rating	IP 66 (protection against heavy rain)	
Operating temperature range	-10 °C to +40 °C (+14 °F / +104 °F)	
Length x width x height	193 mm x 60 mm x 65 mm	187 mm x 60 mm x 65 mm
Weight	450 g	410 g
Order no.	527010	527011

Subject to changes in design and scope of delivery as a result of ongoing technical development.

FOCUSING ON THE ESSENTIALS.



Sensor



Optical magnification



Display

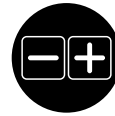

Optical quality



Connectivity

Benefits



Field of view (100 m)



Range

Main use



Raised Hide/forest



Stalking/forest



Raised Hide/field



Stalking/field

ZEISS Thermal Imaging Cameras

ZEISS DTI 3/25

384 x 288 px

1.8 x

1,280 x 960 px

17 microns

HD LCOS

Fine, gradual zoom adjustment
1,0 x – 4,0 x
magnification in 0.5 x increments
Perfect combination of magnification and detail recognition

Manage and share photos/videos
Watch livestreamed hunting experiences

26 m

880 m

DTI 3/25

ZEISS DTI 3/35

384 x 288 px

2.5 x

1,280 x 960 px

17 microns

HD LCOS

Fine, gradual zoom adjustment
1,0 x – 4,0 x
magnification in 0.5 x increments
Perfect combination of magnification and detail recognition

Manage and share photos/videos
Watch livestreamed hunting experiences

19 m

1,235 m

DTI 3/35

ZEISS Thermal Imaging Clip-Ons

ZEISS DTC 3/25

384 x 288 px

1.0 x

1,024 x 768 px

12 microns

HD AMOLED

No digital zoom, riflescope magnification can be used

Digital zeroing assist
Programmable and customizable via app (4 profiles) can be operated via app

18.4 m

1,300 m

DTC 3/25

ZEISS DTC 3/38

384 x 288 px

1.0 x

1,024 x 768 px

12 microns

HD AMOLED

No digital zoom, riflescope magnification can be used

Digital zeroing assist
Programmable and customizable via app (4 profiles) can be operated via app

12.3 m

1,950 m

DTC 3/38

RIFLESOPES FROM ZEISS

A PERFECT SIGHT. WITH THE RIGHT RIFLESCOPE.

As different as each individual's hunting experiences are, so are the demands that hunters place on their riflescopes. That's why the developers at ZEISS know that the perfect riflescope is the one that best suits the hunter's individual requirements.

Riflescopes have to accommodate different types of hunting and individual requirements in terms of weight, magnification, light transmission, field of view, usability, and image quality.

ZEISS has found the right answer to this challenge: various models that differ in performance and product characteristics in such a way that the company covers every hunting situation with this range. Despite all the differences, however, they have one essential thing in common: leading ZEISS quality.

No matter what challenges you face on the hunt, ZEISS has the right optical devices. Thanks to a selection of reliable top-quality products that can respond to individual needs and demands, you always have the optimal companion at your side: your ZEISS riflescope.

Further information is available on our website at www.zeiss.com/hunting/riflescopes



Riflescopes from ZEISS feature a wide range of advanced technologies and innovations. The following pages explain which products offer which specific features and benefits in detail. Here's an initial overview:

A BRIGHT AND HIGH-CONTRAST VIEW

Thanks to an intelligent combination of the highest quality glass types, coatings, and state-of-the-art optical design.

MAXIMUM PRECISION

Ultra-fine illuminated dot for minimal target subtension.

EXCELLENT ERGONOMICS

Functional control elements and intelligent illuminated dot.

EXTREMELY VERSATILE

Different magnification ranges from 1.1x to an impressive 60x magnification.

WEATHER RESISTANCE

Always a clear view thanks to a surface featuring our LotuTec® coating that repels dust, dirt, and water.



OUTSTANDING OPTICS FOR THE HIGHEST DEMANDS.

ZEISS V8

The new generation of ZEISS V8 riflescopes helps hunters enjoy more successful moments on the hunt than any other riflescope from ZEISS thanks to the combination of sophisticated features and how they interact with each other perfectly. A riflescope has never been this flexible and versatile.

Outstanding optical quality, an extra-large eye box for fast target acquisition, and the ultrafine illuminated dot make them unsurpassed companions in any hunting situation. ASV Advanced LongRange rounds out the list of ZEISS V8 riflescopes' numerous features, achieving the longest possible shooting distances thanks to its wide adjustment range. This is how ZEISS V8 riflescopes always guarantee absolute precision and perfection – quality made in Germany for maximum hunting success.

UFL Concept

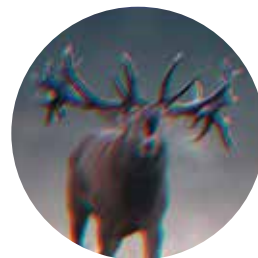

Standard glass

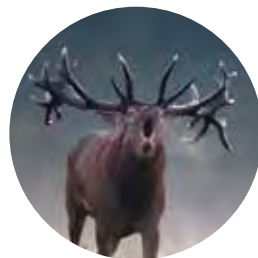

UFL Concept

The UFL concept combines selected premium lenses made from high-quality fluoride glass into a system that delivers extremely lifelike images and vibrant details.

Innovative technologies

Ergonomically designed multi-function button to control the illuminated dot combined with intelligent motion sensor technology to automatically activate the dot when the weapon is brought to bear.



Rapid target acquisition

An extra-large eye box helps hunters quickly and easily acquire targets, resulting in higher success rates in dynamic hunting situations.

Maximum performance meets elegant design

The center tube diameter of 30 or 34 mm offers a compact and mechanically sturdy design solution and more flexibility in reticle selection.

Unmatched long-range shooting performance

With an adjustment range of up to 140 cm and a click value of 1 cm/100 m per click, the ASV-Advanced LongRange (ASV-ALR) bullet drop compensation allows hunters to make corrections for precise targeting at long ranges.

THE MOST VERSATILE RIFLESCOPE. ZEISS V8.

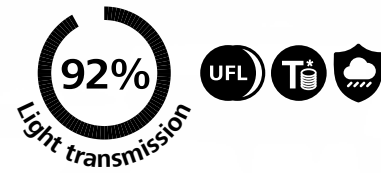

Now with a
30 mm
tube!



Perfect sight on target.

- Outstanding optical quality.
- Maximum field of view and extra-large eye box for rapid target acquisition.
- Ultrafine illuminated dot – easy and precise to operate.
- For shots at the maximum distance thanks to ASV-LongRange and ASV-Advanced LongRange.
- Stable and shot-proof – ideally suited for use with clip-on attachments.



ZEISS V8 1.1–8×24

The V8 1.1–8×24 gives the shooter more room to position their eye and makes target acquisition much faster – a decisive advantage on driven hunts.



ZEISS V8 1.8–14×50

Thanks to its large field of view of 23 meters at 100 meters at the lowest magnification, its outstanding optical quality with relaxed viewing capabilities, and its low weight, the V8 1.8–14×50 is the perfect choice for any hunting situation.



ZEISS V8 2.8–20×56

The 20× magnification and optional bullet drop compensation make the V8 2.8–20×56 excellent for long-range shooting.



ZEISS V8 4.8–35×60

With 35× magnification combined with optional bullet drop compensation, the V8 4.8–35×60 represents the ultimate in long-range shooting performance.



OPTICAL EXPERTISE

Comfortable viewing

The eye box is the area where the hunter completely sees the entire image. In ZEISS riflescopes, it is particularly comfortable due to its size. This provides the hunter more room to position their eye and makes target acquisition much faster – a decisive advantage on driven hunts.



Viewing
ZEISS riflescope

COMPARISON OF ZEISS V8 MODELS.

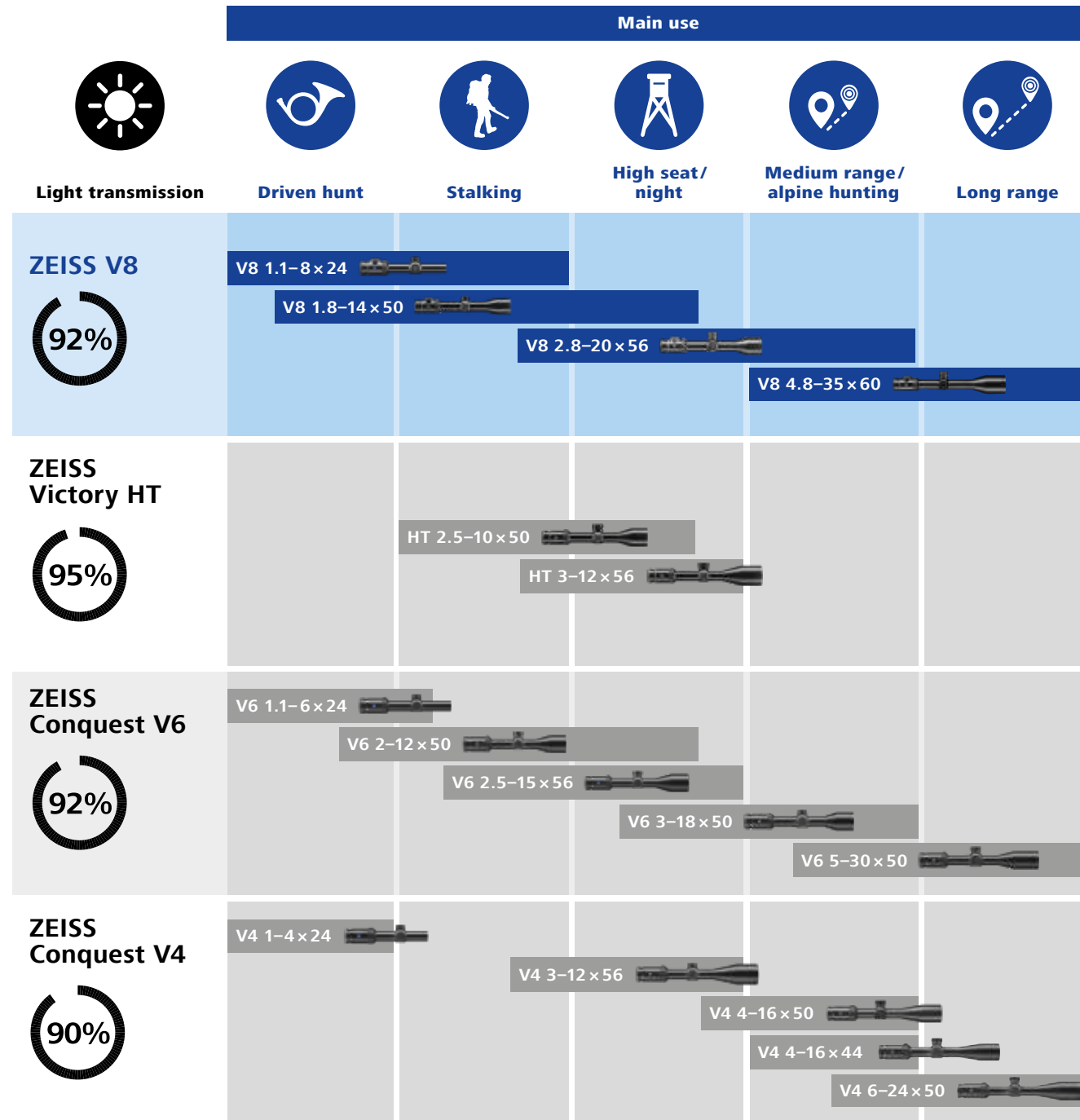

TECHNICAL SPECIFICATIONS.

ZEISS V8 riflescopes	V8			
	1.1-8x24	1.8-14x50	2.8-20x56	4.8-35x60
Model				
Magnification	1.1x-8x	1.8x-13.5x	2.8x-20x	4.8x-35x
Effective lens diameter	10.6-24 mm	18.6-50 mm	27.5-56 mm	48.1-60 mm
Exit pupil diameter	9.9-3.1 mm	10.3-3.7 mm	9.9-2.8 mm	9.9-1.7 mm
Twilight factor	3.4-13.9	5.1-26	7.9-33	13.6-45.8
Field of view (100 m)	39.6-5.4 m	23-3.1 m	15.5-2.1 m	8.6-1.2 m
Objective viewing angle	22.2°-3°	13.1°-1.8°	8.8°-1.2°	4.9°-0.7°
Diopter adjustment range	-3.5/+2 D			
Eye relief	92 mm			
Parallax setting	100 m	50 m-∞		
Vertical adjustment range at 100 m	500 cm	310 cm	210 cm	140 cm
Windage adjustment range at 100 m	320 cm	200 cm	135 cm	85 cm
Adjustment per click at 100 m	1 cm			
Centre tube diameter	30 mm			34 mm
Eyepiece tube diameter	46 mm			
Lens tube diameter	30 mm	56 mm	62 mm	67 mm
Coating	LotuTec®			
Nitrogen-filled	Yes			
Watertightness	400 mbar			
Operating temperature	-25 °C / +50 °C			
Length	283 mm	343 mm	350 mm	399 mm
Selectable illuminated reticle	54, 60	54, 60	43, 60	43, 60
Weight with illuminated reticle	without inner rail	550 g	720 g	795 g
	with inner rail	590 g	750 g	830 g
Order no. (XXXXXX-XXXX-XXX)	without inner rail	52 21 01-	52 21 11-	52 21 31-
	with inner rail	52 21 00-	52 21 10-	52 21 30-
Available illuminated reticle (XXXXXX-XXXX-XXX)	43	-	-	-9943-
	54	-9954-	-9954-	-
	60	-9960-	-9960-	-9960-
Bullet Drop Compensation (ASV) (XXXXXX-XXXX-XXX)	without ASV	-000	-000	-000
	ASV (elevation)	-	-040	-040
	ASV (elevation and windage)	-	-050	-050
Available ASV	-	ASV-LR	ASV-LR	ASV-ALR

Example of a complete order number for ZEISS V8 1.8-14x50 with inner rail, reticle 60 and ASV-LR (elevation): 522110-9960-040
Subject to changes in design and scope of delivery as a result of ongoing technical development.

An overview of all available reticles can be found on our website www.zeiss.com/hunting/reticles



FOR HUNTING IN LOW LIGHT. VICTORY HT

The ZEISS Victory HT is the perfect companion for hunting in low light – thanks to a revolutionary optical concept and SCHOTT HT lenses.

ZEISS Victory HT demonstrates its strengths particularly in twilight and in high seat situations – here the riflescopes impress with a light transmission of 95% and more. This is achieved, among other factors, through the perfect interaction of SCHOTT HT lenses and the performance-enhanced ZEISS T* multicoating. Experience hunting in a new dimension – with the brightest lenses in the history of ZEISS.

HT Concept

HT

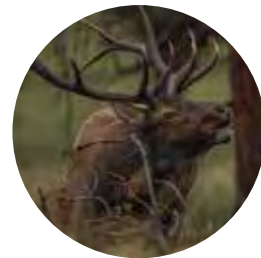

Standard glass

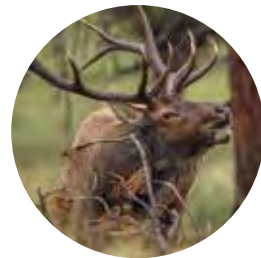

SCHOTT HT GLASS

High-transmission SCHOTT lenses for optimal visibility in twilight and at night.



Pure precision

The ultrafine illuminated dot with extremely low subtension of 3.3 millimeters at 100 meters offers maximum precision, even when aiming at the smallest targets and at long distances.

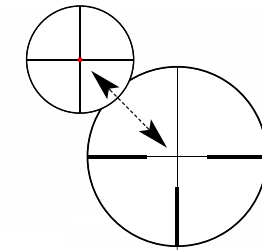

Powerful at a distance

Combined with the optional ASV+, the Victory HT ensures hunters are successful, even at long distances.



Light in the darkness

The combination of SCHOTT HT glass, ZEISS T* multicoating, and the Abbe-König prism system results in light transmission of 95% and more.

HT T* SCHOTT HT GLASS

Stable and steady

The Victory HT is ideally suited for use with clip-on attachments.

VERSATILE AND BRIGHT. VICTORY HT.

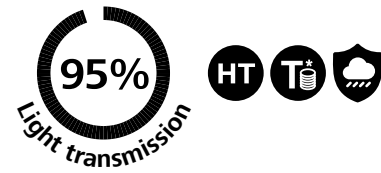

HT 2.5 – 10 × 50

The versatile riflescope for all hunting applications – whether shooting on the move or from a raised hide, this riflescope is up to any hunting challenge thanks to the optional ASV+. The Victory HT’s optical design really comes into its own in the twilight.



HT 3 – 12 × 56

The specialist for night hunting. Thanks to the use of SCHOTT HT glass, the brightest riflescope from ZEISS is perfect for use at night. Combined with the optional ASV+, the Victory HT ensures hunters are successful, even at long distances.

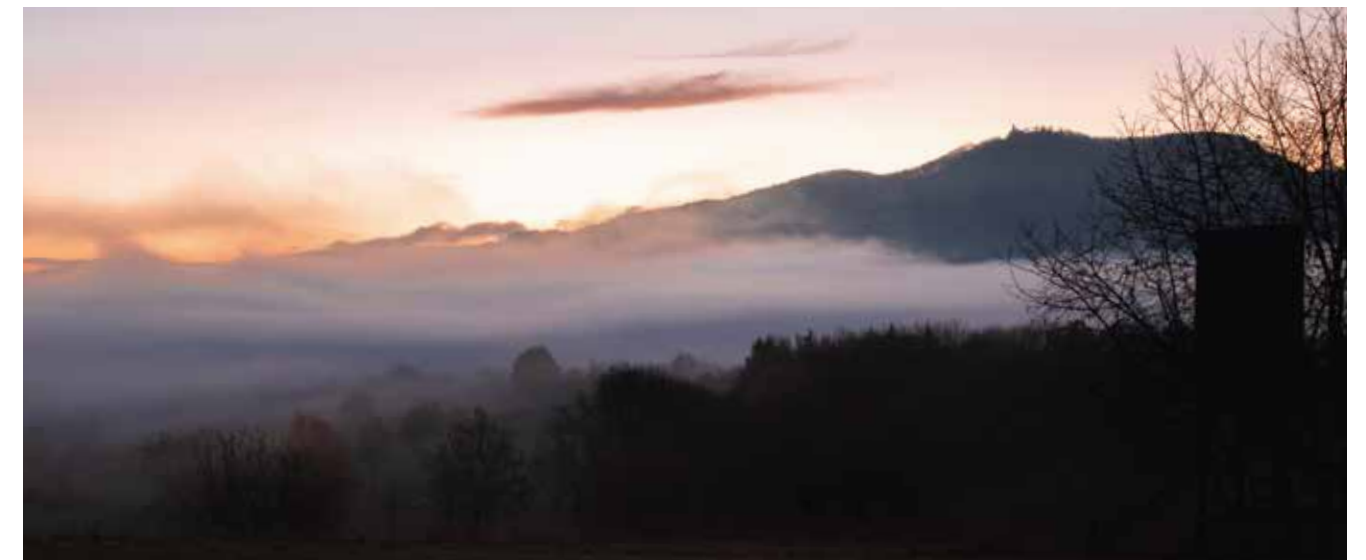

See more than others.

- SCHOTT HT lenses for a bright and high-contrast view.
- ASV+ (can be added later) including nine ballistic rings to match your ammunition.
- Ultra-fine illuminated dot for minimal target subtension.
- Continuously adjustable illuminated dot with automatic shut-off.
- Stable and shot-proof – ideally suited for the use of clip-on attachments.

OPTICAL EXPERTISE

Stable and shot-proof, even with clip-on attachments. In laboratory tests, ZEISS demonstrated that the ZEISS Victory V8, ZEISS Victory HT, ZEISS Conquest V6, and ZEISS Conquest V4 exhibit the expected and necessary degree of stability required for use with clip-on devices. With a clip-on attachment, any ZEISS riflescope can be converted into a night vision or thermal imaging device.

OPTICAL EXPERTISE

Ultrafine illuminated dot for minimal subtension and a reliable, ethical shot.

The ZEISS HT, V8, and V6 riflescopes feature an ultrafine illuminated dot. This keeps subtension low for a more accurate shot.

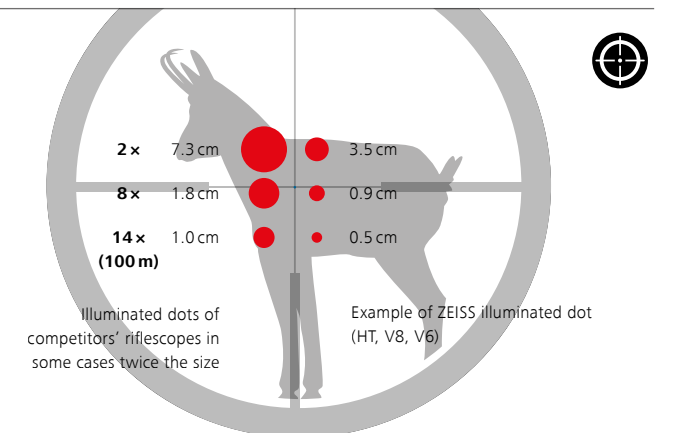

COMPARISON OF VICTORY HT MODELS.

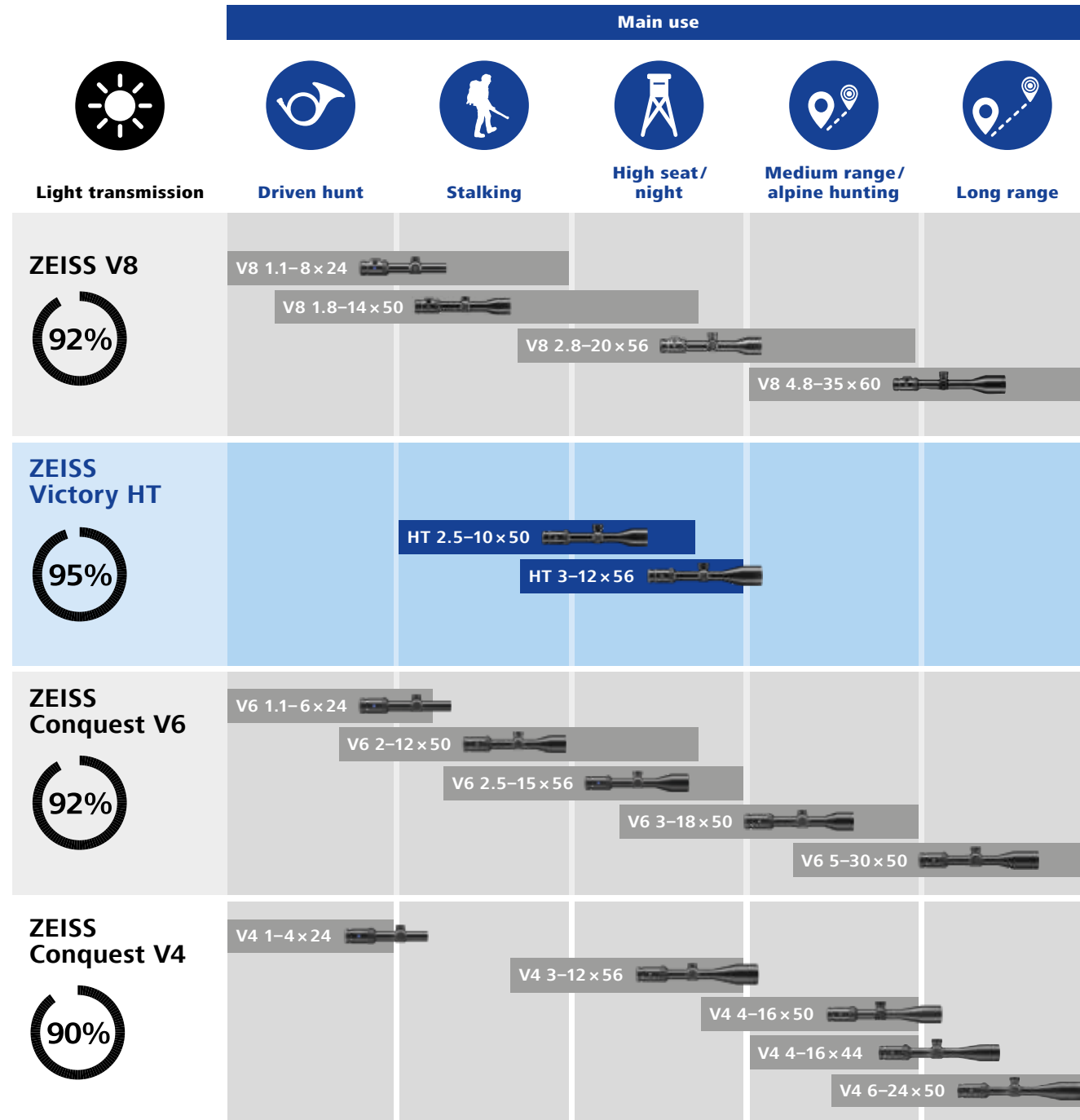

TECHNICAL SPECIFICATIONS.

Victory riflescopes	HT		
	2.5-10x50	3-12x56	
Model			
Magnification	2.5x-10x	3x-12x	
Effective lens diameter	37.7-50 mm	44-56 mm	
Exit pupil diameter	15-5 mm	14.9-4.7 mm	
Twilight factor	7.1-22.4	8.5-25.9	
Field of view (100 m)	14.8-4.1 m	12.5-3.5 m	
Objective viewing angle	8.5°-2.3°	7.2°-2°	
Diopter adjustment range	-4/+2 D		
Eye relief	90 mm		
Parallax setting	100 m		
Vertical adjustment range at 100 m	140 cm	120 cm	
Windage adjustment range at 100 m	140 cm	120 cm	
Adjustment per click at 100 m	1 cm		
Centre tube diameter	30 mm		
Eyepiece tube diameter	42 mm		
Lens tube diameter	56 mm	62 mm	
Coating	LotuTec®		
Nitrogen filling	Yes		
Watertightness	400 mbar		
Operating temperature	-25 °C / +50 °C		
Length	321 mm	347 mm	
Selectable illuminated reticle	60	60	
Weight with illuminated reticle	without inner rail	525 g	573 g
	with inner rail	550 g	598 g
Order no. (XXXXXX-XXXX-XXX)	without inner rail	52 24 25-	52 24 35-
	with inner rail	52 24 24-	52 24 34-
Available CMMs illuminated reticle (XXXXXX-XXXX-XXX)	43	-	-
	54	-	-
	60	-9960-	-9960-
Bullet Drop Compensation (ASV) (XXXXXX-XXXX-XXX)	without ASV	-000	-000
	ASV (elevation)	-010	-010
	ASV (elevation and windage)	-020	-020
Available ASV	ASV+	ASV+	

Subject to changes in design and scope of delivery as a result of ongoing technical development.

An overview of all available reticles can be found on our website www.zeiss.com/hunting/reticles



FLEXIBILITY FOR EVERY HUNTING SITUATION.

CONQUEST V6

With Conquest V6, ZEISS has set a new standard in the upper mid-range. Whether for sitting or stalking game, driven hunts or long-range shooting – the riflescope with 6× zoom will impress you in any hunting situation. It combines legendary ZEISS quality with leading-edge technology and a robust, functional design – and it is excellent value for the money.

Light transmission of 92 %, modern multilayer coatings, and wide fields of view ensure that the ZEISS Conquest V6 provides outstanding optical quality and clarity every time. The premium lenses are protected by a black, matt anodized aluminum housing. The LotuTec® coating and optionally available ballistic turrets round out the package.

FL Glass



Standard glass

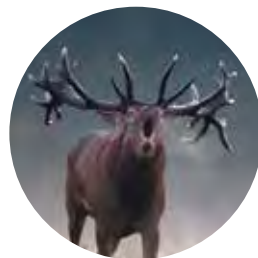

FL Glas

The combination of ZEISS T* multicoating and fluoride glass results in natural images.

Reliable and rugged

The extremely rugged design and reliable mechanical components guarantee safe operation under all conditions. Quality made in Germany.



Fast and precise

Optional ballistic turrets make it possible to stay aimed at the target for maximum hunting ranges. The large exit pupil supports rapid target acquisition.



Sharp and bright

Thanks to light transmission values of 92 %, the Conquest V6 is ideally suited for hunting from a raised hide and, thanks to the optional ballistic turrets, for shooting at long distances. The illuminated reticle features minimal subtension for highly accurate shots.

Intelligent and convenient

Automatic activation and deactivation of the illuminated dot by the intelligent motion sensor technology extends the battery life and thus the operating time of the illuminated dot.

THE HIGH-PERFORMANCE RIFLESCOPE WITH 6 × ZOOM. CONQUEST V6.

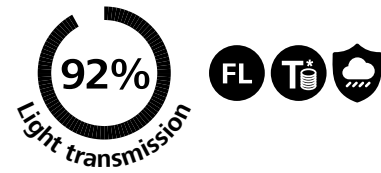

A perfect view of the target.

- Outstanding optical quality.
- Maximum field of view and extra-large eye box for rapid target acquisition.
- Ultrafine illuminated dot – easy and precise to operate.
- High ranges due to optionally available ballistic turrets.



V6 2.5 – 15 × 56

Thanks to high light transmission, the Conquest V6 is ideally suited for hunting from a raised hide and, thanks to the optional ballistic turrets, for shooting at long distances. The illuminated reticle features minimal subtension for highly accurate shots.



V6 1.1 – 6 × 24

On driven hunts, a large field of view ensures that hunters enjoy maximum visibility. Magnification up to 6.5× gives hunters the necessary flexibility and intuitive operation ensures speed on the hunt. At higher magnification, game can still be properly identified and shot at medium range. This represents a clear advantage over simple red dot sights.



V6 2 – 12 × 50

This compact and versatile rifle scope is a reliable companion in the hunting grounds. The Conquest V6 2–12×50 is powerful into the twilight hours with its extremely fine illuminated dot and high magnification range.



V6 3 – 18 × 50

Versatile at medium to long range, this rifle scope features a lightweight, slim design. It is also extremely reliable and easy to use. Optionally available with a ballistics turret. Compatible with reticle 6 and the ZBR-2/ZMOA-2 ballistic reticle.



V6 5 – 30 × 50

The Conquest V6 5–30×50 offers high magnification for long-range shooting on the one hand and a large zoom range for maximum flexibility on the other. The lightweight, slim design is another advantage. Compatible with the ZBR-1/ZMOA-1 ballistic reticle as well as reticle 43.



COMPARISON OF CONQUEST V6 MODELS.

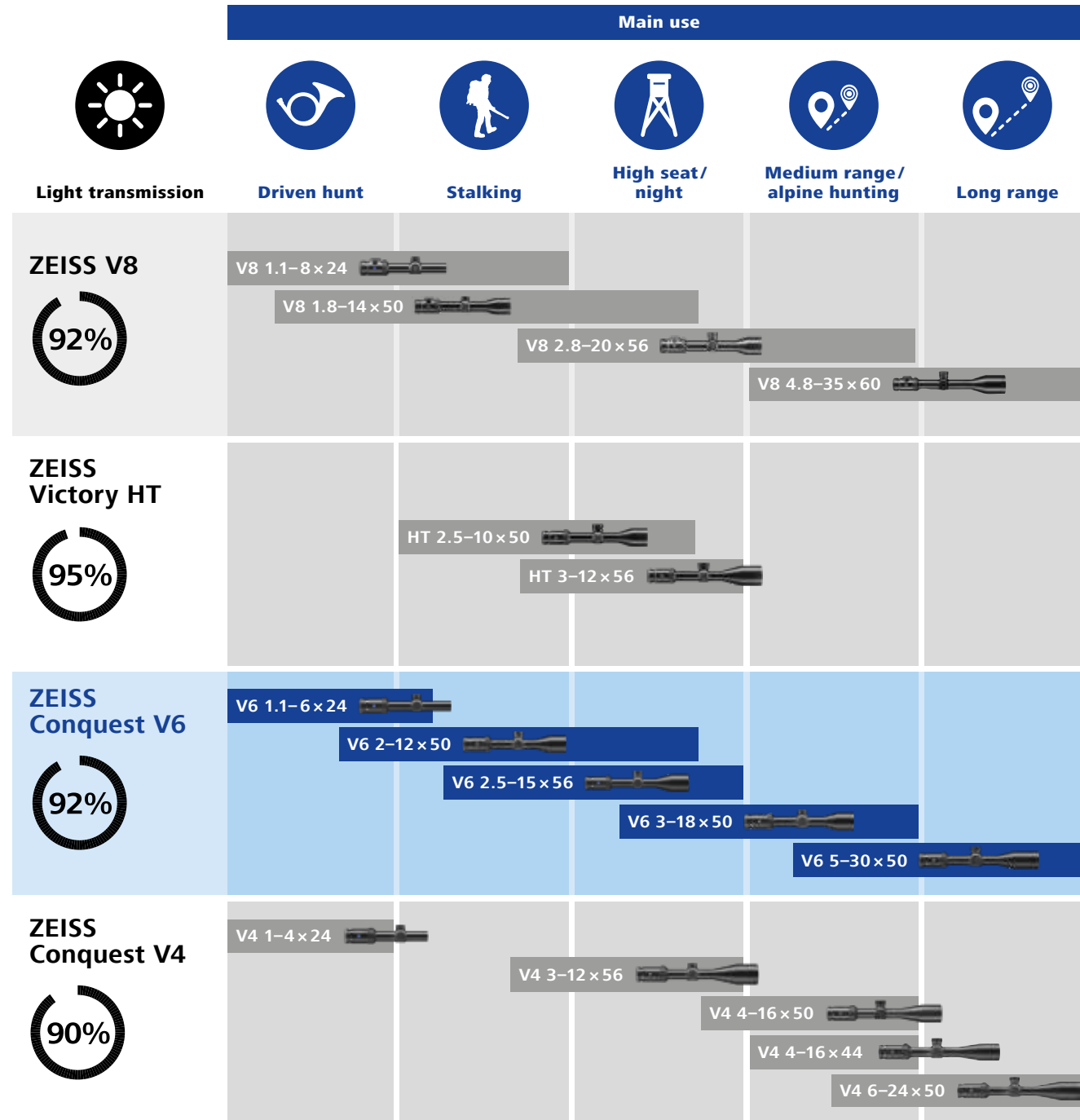

TECHNICAL SPECIFICATIONS.



Conquest riflescopes Model	V6					
	1.1-6x24	2-12x50	2.5-15x56	3-18x50	5-30x50	
Magnification	1.1x-6.5x	2x-12x	2.5x-15x	3x-18x	5x-30x	
Effective lens diameter	10.5-24 mm	19.4-50 mm	24.3-56 mm	28.6-50 mm	47.3-50 mm	
Exit pupil diameter	9.5-3.7 mm	9.7-4.2 mm	9.7-3.7 mm	9.5-2.8 mm	9.5-1.7 mm	
Twilight factor	3.1-12.5	5.7-24.5	7.1-29.0	8.5-30.0	14.1-38.7	
Field of view (100 m)	38.1-6.6 m	20.5-3.4 m	16.4-2.7 m	12.4-2.1 m	7.4-1.2 m	
Objective viewing angle	21.6°-3.8°	11.7°-2.0°	9.4°-1.6°	7.1°-1.2°	4.2°-0.7°	
Diopter adjustment range	+2/-3 D					
Eye relief	90 mm					
Parallax setting	100 m	100 m	100 m	∞	∞	
Adjustment range at 100 m	300 cm	250 cm	200 cm	300x170 m	180x100 m	
Adjustment per click at 100 m	1 cm			1/4 MoA (0.7 cm/100 m)		
Centre tube diameter	30 mm					
Eyepiece tube diameter	45.5 mm					
Lens tube diameter	30 mm	56 mm	62 mm	56 mm	56 mm	
Coating	LotuTec®					
Nitrogen-filled	Yes					
Watertightness	400 mbar					
Operating temperature	-25 °C/+50 °C					
Length	290 mm	335 mm	352 mm	338 mm	380 mm	
Weight	without inner rail	505 g	620 g	690 g	630 g	740 g
	with inner rail	545 g	655 g	725 g	Not available	Not available
Order no. (XXXXXX-XXXX-XXX)	without inner rail	52 22 05-	52 22 25-	52 22 35-	52 22 41-	52 22 51-
	with inner rail	52 22 04-	52 22 24-	52 22 34-	-	-
Available Reticles (XXXXXX-XXXX-XXX)	60	-9960-	-9960-	-9960-	-	-
	20	-	-	-	-9906-	-9906-
	43	-	-	-	-	-9943-
	ZMOA-2	-	-	-	-9994-	-
	ZMOA-1	-	-	-	-	-9993-
	ZBR-2	-	-	-	-9992-	-
	ZBR-1	-	-	-	-	-9993-
Bullet Drop Compensation (ASV) (XXXXXX-XXXX-XXX)	without ASV	-000	-000	-000	-000	-
	Ballistic Turret	-	-060	-060	-	-
	Ballistic Turret & External Windage	-	-	-	-070	-070

Example of a complete order number for Conquest V6 2.5-15x56 with inner rail, reticle 60, and ASV (elevation): 522234-9960-060
Subject to changes in design and scope of delivery as a result of ongoing technical development.

An overview of all available reticles can be found on our website
www.zeiss.com/hunting/reticles



RUGGED, COMPACT, AND PRECISE.

CONQUEST V4

The Conquest V4 line of high-performance riflescopes combines the tried-and-true ZEISS optics concept with a rugged and functional design. The compact design and the balance between a large field of view and magnification are ideal for all types of hunting.

The V4 models are equipped with a 4x zoom and precise, absolutely reliable mechanical components. Special models have a ballistic turret with large reticle adjustment range (elevation and windage). This gives the shooter the necessary flexibility for different forms of hunting. Ballistic reticles are also optionally available to rapidly correct elevation and windage without any mechanical adjustment.

LotuTec®



Even in wet weather, there are impressive things to see during the hunt. ZEISS developed LotuTec® precisely for this purpose. This is a coating on the lenses that provides unobstructed visibility in all weather conditions.



PRODUCT PROFILE

HIGH-QUALITY OPTICS FOR RUGGED HUNTING USE.



Functional mechanical parts
Absolutely reliable: the mechanical parts prove their worth in every situation that demands quick reactions.

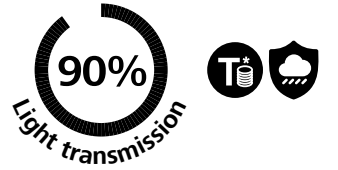

Ballistic turret

With the ballistic turret's wide reticle adjustment range, the hunter has the flexibility needed for a variety of different hunting methods.



Ballistic reticles

The ballistic reticles enable quick correction of elevation and windage.

Stable and shot-proof

The Conquest V4 is ideally suited for use with clip-on attachments.



V4 1-4x24

Has proven to be the perfect riflescope for short-range hunting and situations which require the hunter to rapidly acquire the target. At higher magnification, game can still be properly identified and shot at medium range. This represents a clear advantage over simple red dot sights.



V4 3-12x56

This scope is suitable both for hunting from a blind as well as hunting long range. Thanks to the large-diameter lens and illuminated reticle, high accuracy is guaranteed – even in low light conditions.



V4 4-16x50

Thanks to its zoom range, this riflescope is the perfect choice for daily use over medium and long distances in difficult lighting conditions. The 16x zoom setting makes it easy to see every detail of the animal in order to accurately identify it.



V4 6-24x50

The 24x magnification and parallax compensation make this scope a specialist for precision shots.



V4 4-16x44

With its compact design, this riflescope is ideal for all forms of hunting thanks to the perfect balance between a large field of view and magnification.



ACCESSORIES



Neoprene Cover

When hunting, conditions can get a little tough. To better protect your riflescope from the elements, ZEISS offers the appropriate neoprene cover for ZEISS V8, V6, V4, and HT series riflescopes.



Throw Lever for ZEISS V8, Conquest V6, and V4

To quickly change magnification when it matters.

OPTICAL EXPERTISE



Stable and shot-proof, even with clip-on attachments.

In laboratory tests, ZEISS demonstrated that the ZEISS Victory V8, ZEISS Victory HT, ZEISS Conquest V6, and ZEISS Conquest V4 exhibit the expected and necessary degree of stability required for use with clip-on devices. With a clip-on attachment, any ZEISS riflescope can be converted into a night vision or thermal imaging device.

COMPARISON OF CONQUEST V4 MODELS.

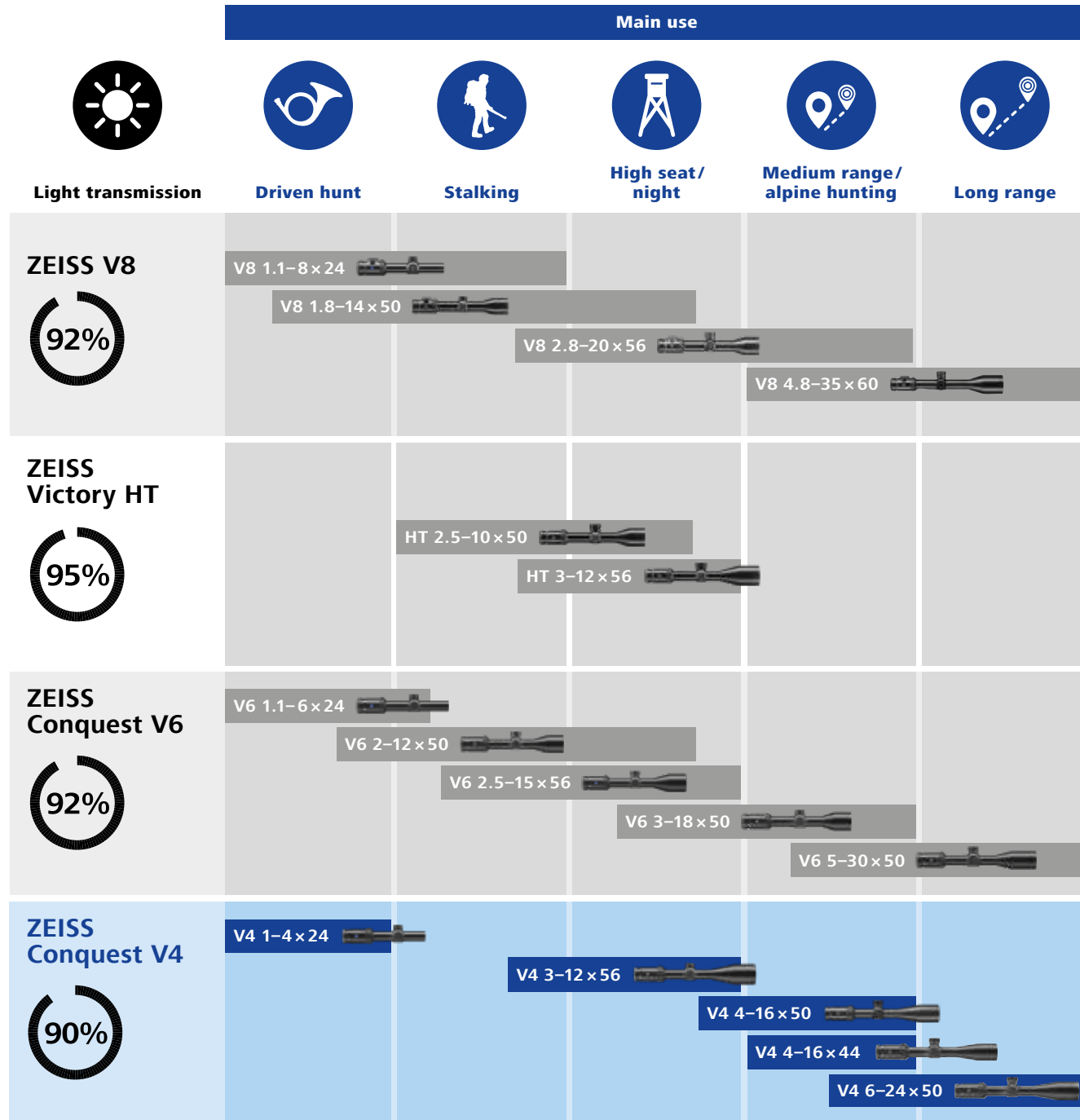

TECHNICAL SPECIFICATIONS.

Conquest riflescopes	V4					
	1-4x24	3-12x56	4-16x44	4-16x50	6-24x50	
Model						
Magnification	1x-4x	3x-12x	4x-16x	4x-16x	6x-24x	
Effective lens diameter	12.1-24 mm	27.7-56 mm	33.2-44 mm	34.5-50 mm	44.9-50 mm	
Exit pupil diameter	11.9-6 mm	9.2-4.7 mm	8.5-2.8 mm	8.5-3.1 mm	7.5-2.1 mm	
Twilight factor	3.5-9.8	9.1-25.9	11.5-26.5	11.7-28.3	16.4-34.6	
Field of view (100 m)	38-9.5 m	12.7-3.2 m	9.5-2.4 m	8.7-2.2 m	6.3-1.6 m	
Objective viewing angle	21.5°-5.4°	7.2°-1.8°	5.4°-1.4°	5.4°-1.4°	3.6°-0.9°	
Diopter adjustment range	+2/-3 D					
Eye relief	90 mm					
Parallax setting	91.4 m		9.1 m-∞ (10 yds-∞)			
Adjustment range at 100 m	300 cm	200 cm	230x175 cm			
Adjustment per click at 100 m	1.4 cm	1/4 MoA (0.7 cm/100 m)				
Centre tube diameter	30 mm					
Eyepiece tube diameter	44 mm					
Lens tube diameter	30 mm	62 mm	50 mm	56 mm	56 mm	
Coating	LotuTec®					
Nitrogen filling	Yes					
Watertightness	400 mbar					
Operating temperature	-20 °C / +50 °C			-25 °C / +50 °C	-20 °C / +55 °C	
Length	256 mm	368 mm	356 mm	368 mm	368 mm	
Weight	without inner rail 470 g	610 g	640 g	652 g	690 g	
Order no. (XXXXXX-XXXX-XXX)	without illuminated reticle with ring assembly	- 522905-	522921- 522925-	522931- 522935-	- 522945-	522951- 522955-
Available reticles (XXXXXX-XXXX-XXX)	60 20 ZMOA-2 ZMOA-1 ZMOAi-1 ZBR-2 ZBR-1 ZBi ZMOAi-20 ZMOAi-T20 ZMOAi-T30	-9960- - - - - - - - - - -	-9960- -9920- - - - - - - - - -	-9960- -9920- -9994- - - -9992- - -9968- - - -9964- -	- - - -9993- - - -9968- -9964- -	-9960- - - -9993- -9993- - -9991- -9968- -9989- -9965- -
Bullet Drop Compensation (ASV) (XXXXXX-XXXX-XXX)	without ASV Ballistic Turret Ballistic Turret & External Locking Windage	-000 - -	-000 - -	-000 -080 -090	- -080 -090	- -080 -090

Example of a complete order number for Conquest V4 3-12x56 with inner rail, reticle 60: 522925-9960
Subject to changes in design and scope of delivery as a result of ongoing technical development.

An overview of all available reticles can be found on our website www.zeiss.com/hunting/reticles

FOCUSING ON THE ESSENTIALS.

Light transmission	Optical quality	ASV	Operating the illuminated dot	Reticles	Mounting

ZEISS V8

92%

UFL

T*

9 ballistic rings available standard
↓
Ability to directly check shooting distances
Can be upgraded with ASV

Optimized multifunctional button, can be used with both hands

Continuously variable illuminated dot brightness control

Ultrafine illuminated dot for minimal target subtension

Automatic shutoff with position sensor

Reticle 43
Reticle 54
Reticle 60

Ring and inner rail

Stable and steady during shots when used with thermal imaging attachments (up to 2,000 g weight)

ZEISS Victory HT

95%

HT

T*

9 ballistic rings available standard
↓
Ability to directly check shooting distances
Can be upgraded with ASV

Multifunctional button

Continuously variable illuminated dot brightness control

Ultrafine illuminated dot for minimal target subtension

Automatic shutoff

Reticle 60

Ring and inner rail

Stable and steady during shots when used with thermal imaging attachments (up to 2,000 g weight)

ZEISS Conquest V6

92%

FL

T*

Multiple revolutions of the turret for high-precision shots at maximum distances
Can be upgraded with ASV

Multifunctional button

Continuously variable illuminated dot brightness control

Ultrafine illuminated dot for minimal target subtension

Automatic deactivation position sensor

Reticle 6 (Z-Plex)
Reticle 43 (non-illuminated)
Reticle 60
ZMOA-1
ZMOA-2
ZMOA-4
ZBR-1
ZBR-2

Ring and inner rail

Stable and steady during shots when used with thermal imaging attachments (up to 2,000 g weight)

ZEISS Conquest V4

90%

T*

Multiple revolutions of the turret for high-precision shots at maximum distances
Can not be upgraded with ASV

Multifunctional button

10-step illuminated dot brightness control

Reticle 20 (Z-Plex)
Reticle 60
ZMOAi-1
ZMOA-1
ZMOA-2
ZBR-1
ZBR-2
ZBi
ZMOAi-20
ZMOAi-T20
ZMOAi-T30
ZMOA-T30

Ring

Stable and steady during shots when used with thermal imaging attachments (up to 2,000 g weight)

Main use

Driven hunt	Stalking	High seat/night	Medium range/alpine hunting	Long range

V8 1.1-8x24				
V8 1.8-14x50				
	V8 2.8-20x56			
		V8 4.8-35x60		
	HT 2.5-10x50			
		HT 3-12x56		
V6 1.1-6x24				
V6 2-12x50				
	V6 2.5-15x56			
		V6 3-18x50		
			V6 5-30x50	
V4 1-4x24				
	V4 3-12x56			
		V4 4-16x50		
			V4 4-16x44	
				V4 6-24x50

HT Concept High-transmission SCHOTT lenses for optimal sighting and target resolution in low-light conditions.	FL Fluoride glass and SCHOTT glass for natural images and optimal target resolution.	UFL Concept System of selected premium lenses made from high-quality fluoride glass for extremely lifelike images and vibrant details.
LotuTec® For fast and easy lens cleaning.	T* Multicoating for sharp, high-contrast images.	An overview on the subject of reticles including diagrams can be found on the next page.

FOR DECISIONS THAT REQUIRE MAXIMUM PRECISION.

Reticle for ZEISS riflescopes

ZEISS works constantly on the development of reticles, consistently sets new standards, and impresses with incomparably high levels of precision.

Standard non-illuminated reticle

Non-illuminated reticles are versatile and precise. They are ideal for hunting situations from excellent light conditions to light twilight. In addition, non-illuminated reticles can be used to measure distances – the finely spaced intervals of the reticle bars can be used to determine practical information about the distance to the game being hunted.

Illuminated reticle

Depending on how bright the illuminated dot or crosshair is, ZEISS riflescopes can be divided into two fundamentally different types of illuminated reticles:

Versions with a very bright illuminated dot are illuminated reticles suitable for daytime and twilight use. These are found in the Victory HT models, the Conquest V6, and the V4, among others, and they are particularly good for quickly acquiring the target when hunting moving game. The second group of illuminated reticles from ZEISS is designed for twilight. The Victory HT models and the ZEISS V8 feature finely-dimmable illuminated dots. These can be perfectly adapted to the lighting conditions, which change considerably with the onset of twilight. If the illuminated dot or illuminated crosshairs were too bright, they would illuminate the target too much in the faint twilight. As such, these illuminated reticles offer the ability to perfectly adjust the brightness, either manually or even automatically, assisted by the rifle scope.

ACCESSORIES



Sunshades

Protect against blinding light on extremely sunny days.



Bullet Drop Compensator (ASV)

For ZEISS V8 and Conquest V6 ballistic turrets. Available with new riflescopes or can be added later.

RETICLES FROM ZEISS (ILLUMINATED)

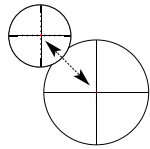
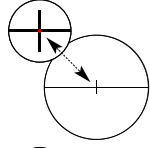
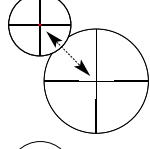
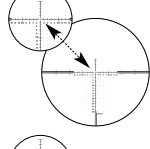
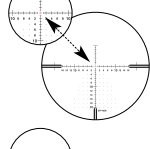
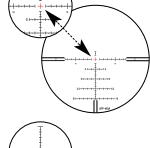
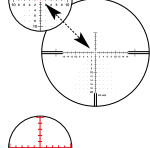
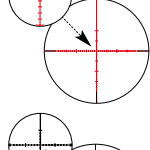
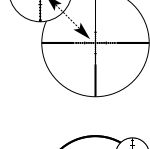
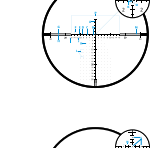
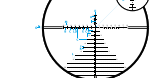
- 
Reticle 43
For ZEISS V8
- 
Reticle 54
For ZEISS V8
- 
Reticle 60
For ZEISS V8, HT, Conquest V6, V4
- 
Reticle ZMOAi-T30 (64)
For Conquest V4
- 
Reticle ZMOAi-T20 (65)
For Conquest V4
- 
Reticle ZBi (68)
For Conquest V4
- 
Reticle ZMOAi-20 (89)
For Conquest V4
- 
Reticle ZMOAi-1 (93)
For Conquest V4
- 
Reticle ZMOA-4 (95)
For Conquest V6
- 
Reticle ZF-MOAI (17)
For LRP S5
- 
Reticle ZF-MRi (16)
For LRP S5

RETICLES FROM ZEISS (NON-ILLUMINATED)

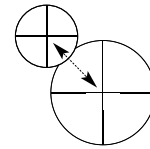
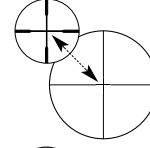
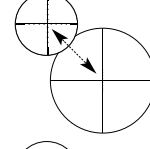
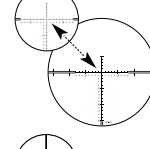
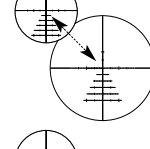
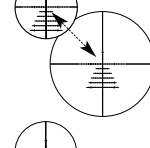
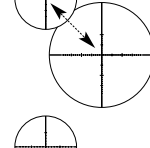
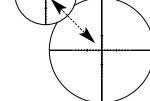
- 
Reticle 6
For Conquest V6
- 
Reticle 20 (Z-Plex)
For Conquest V4
- 
Reticle 43
For Conquest V6
- 
Reticle ZMOA-T30 (64)
For Conquest V4
- 
Reticle ZBR-1 (91)
For Conquest V6, V4
- 
Reticle ZBR-2 (92)
For Conquest V6, V4
- 
Reticle ZMOA-1 (93)
For Conquest V6, V4
- 
Reticle ZMOA-2 (94)
For Conquest V6, V4

NEW OPTICAL DEVICES FROM ZEISS FOR TARGET SHOOTERS.

The reticle in the riflescope can be positioned in the first or in the second image plane. But which option is best suited to which application? The difference between the first focal plane and the second focal plane can be seen when changing the magnification or in the amount of subtension.



The reticle in the first focal plane

A reticle in the first focal plane (in front of the inverting system) changes in the same way as the actual image. The reticle and the image combine to form a single unit, the size of both increasing or decreasing in the same way. As a result, the subtension remains constant at all magnifications, making it easy to estimate the range.

An additional property becomes evident in poor lighting: the bars and lines become wider at higher magnification, making them easier to see. Due to the simultaneous magnification of the reticle and image, the shooter always has all relevant reference numbers in view in order to shoot accurately – the ideal conditions for target shooters and competitions.

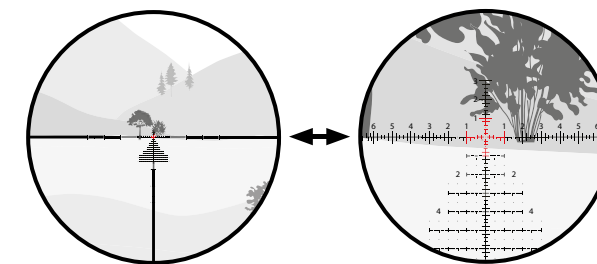

Reticle in the first focal plane (on the objective side):

A change in magnification changes the view of the target and reticle at the same time, i.e., the proportions and subtension remain constant.

The reticle in the second focal plane

In riflescopes with the reticle in the second focal plane, the reticle is behind the inverting system, i.e., in the image plane on the eyepiece side. When the magnification changes (zoom), it does not affect the reticle, which remains constantly fine with minimal subtension – a major benefit when taking long-range shots at high magnification. However, the subtension of the reticles in the second focal plane now depends on the magnification setting. The lower the magnification (the smaller the image), the higher the subtension.

Placing the reticle in the second focal plane is more technically challenging and critical than in the first plane. The moveable parts of the inverting system must be manufactured with extremely tight tolerances to ensure that the image does not unintentionally move up or down when it is enlarged. Because the reticle is fixed in the second focal plane, it would lead to considerable deviations in the point of impact in such cases. Thanks to state-of-the-art manufacturing processes with minimal tolerances, ZEISS can also deliver maximum reliability in this regard across all riflescope classes.

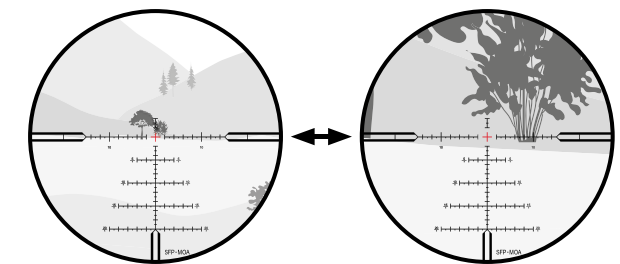

Reticle in the second focal plane (on the eyepiece side):

Changing the magnification only changes the view of the target. The reticle remains unchanged. The subtension changes with the magnification.



HIGH-PERFORMANCE OPTICS FOR PRECISION SHOOTING. ZEISS LRP S5

ZEISS has introduced the LRP S5, a completely new long-range precision (LRP) riflescope that was developed specifically for precision shooting and also impresses hunters with its maximum accuracy at long distances.

The ZEISS LRP S5 318-50 and 525-56 models represent the pinnacle of precision riflescopes available today – and made in Germany, of course. Both models feature a quick-focus eyepiece, a ballistic turret with locking function, and an external windage adjustment that can also be locked in place. The MRAD (milliradian) and MOA (minute of angle) reticles feature extremely fine lines with an open center area and an illuminated dot suitable for daylight use.

High-performance optics



Premium optical design with SCHOTT glass, fluoride glass elements, and T* coatings result in ideal target recognition, target resolution, and maximum light transmission of 90%. The LotuTec® coating ensures shooters have a clear view even in wet weather.

Daylight visible illuminated reticle

Digitally controlled diffractive reticle illumination technology delivers an exceptionally bright illuminated dot regardless of the incident light – allowing you to reliably verify the exact position of the shot on the target. The intensity is continuously adjustable.



Best-in-class total elevation travel

Thanks to the massive total elevation travel of 40.7 MRAD or 140 MOA, the ZEISS LRP S5 can be used to reliably hit targets at a distance of 1,400 meters or more.

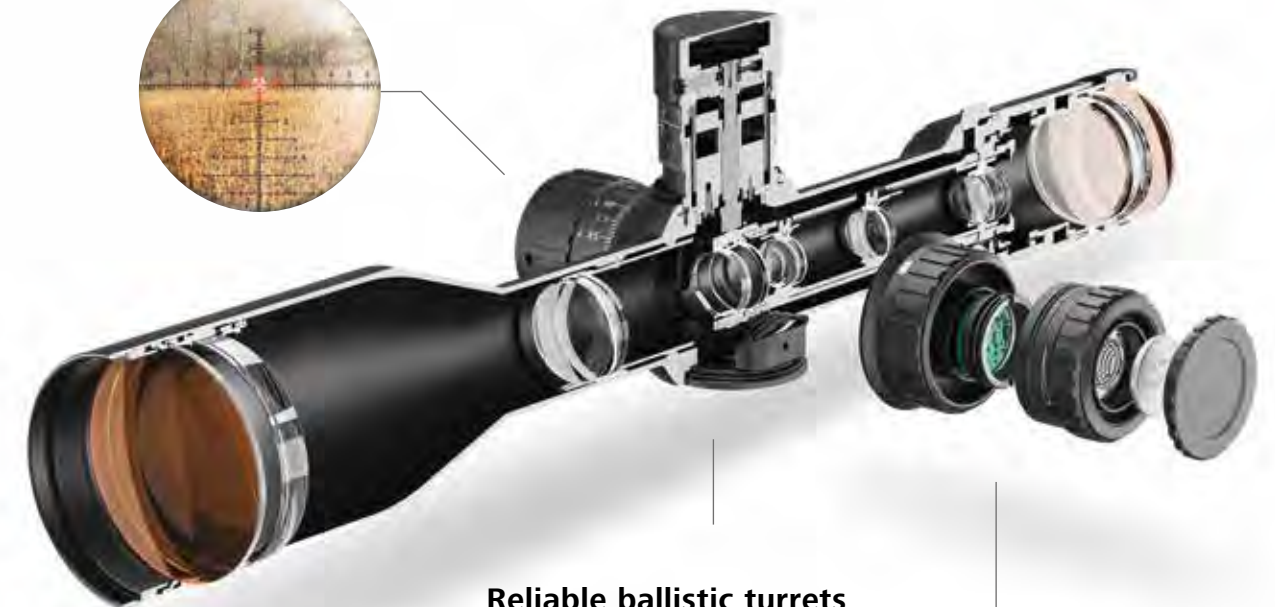

Reliable ballistic turrets

The particularly tactile and precisely designed ballistic turrets offer maximum reliability, even in stressful competitive situations.



Reticle in first focal plane

Highly intuitive design with etched and detailed graduated chrome structures. Numerical indicators and reference marks enable precise, fast aiming at the target.

Side parallax adjustment

With a setting of 25 m to infinity – larger diameter for ideal control.

MASTERFUL PRECISION. ZEISS LRP S5.



S5 318-50

With its extremely large field of view, the ZEISS LRP S5 318-50 is ideal for target shooting and hunting at longer distances. The high-precision scope is the preferred choice for rifle platforms that require more compact optics with excellent performance characteristics.



S5 525-56

The riflescope is perfect for long-range shooting competitions and is an excellent choice for a variety of rifle platforms. With a higher magnification setting, the ZEISS LRP S5 525-56 is also ideal for target shooting, ammunition testing, ammunition development, and hunting at long ranges.



Maximum precision for competitions and hunting.

- Premium optical design.
- Best-in-class total elevation travel – 40.7 MRAD / 140 MOA.
- Exceptionally tactile ballistic towers for high repeatability.
- Quality “Made in Germany” with the highest quality materials.

Turrets



MRAD



MOA



MRAD



MOA

Elevation Turret

The turret incorporates a mechanically lifting design that allows for multi-turn functionality, with more than four complete rotations of total elevation adjustment value. Depending on the configuration of the scope, the adjustment values on the turret are indicated in milliradians (MRAD) or minutes of angle (MOA).

External Locking Windage Turret (ELWT)

The turret incorporates a multi-turn functionality, with approximately two complete rotations of total windage adjustment value. The locking function protects the turret against accidental adjustment.

ZEISS FFP RETICLES

MILLIRADIAN: ZF-MRI.

The ZF-MRi reticle was designed specifically for competitions. The milliradian (MRAD) reticle incorporates a “tree-style” primary structure with useful hash marks, dots, and reference numbers – without the clutter. The points of aim and holds are represented in 0.02, 0.05, and 1.0 MRAD increments; and even numbers are displayed for fast and intuitive visual reference.

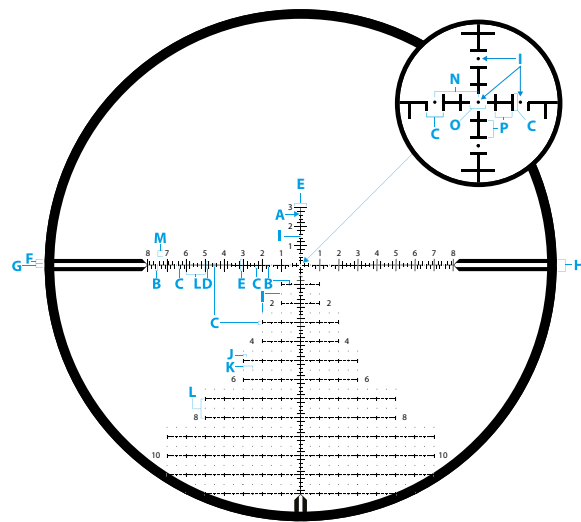

Image above is for illustration purposes.

LRP S5	318-50	525-56		
Unit of measure	MRAD		Distance J	0.2
Line thickness A	0.04	0.03	Distance K	0.5
Distance B	0.1		Distance L	1.0
Distance C	0.2		Standard number size M	0.3
Distance D	0.4		Distance N	0.5
Distance E	0.6		Distance O	0.2
Distance F	0.2		Distance P	0.2
Distance G	0.2		Distance Q	0.9
Distance H	0.6		Distance R	1.2
Dot size I	0.05	0.04	Distance S	1.8

ZEISS LRP S5 318-50 and 525-56 ZF-MRi reticle comparison



@3,6x

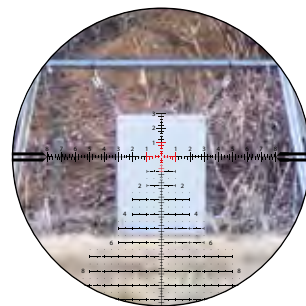

@18x



@5x

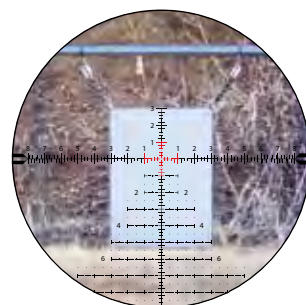

@25x

ZEISS FFP RETICLES

MINUTE-OF-ANGLE: ZF-MOAI.



ZEISS LRP S5 318-50 and 525-56 ZF-MOAI reticle comparison

The ZF-MOAI reticle was designed with precision shooting and long-range hunting in mind. This is a great reticle for the most challenging shots in the field and on the range. The clean and clutter-free reticle utilizes hash marks that represent 1 MOA (minute of angle); even numbers are displayed for fast, intuitive visual reference. The windage dots below centerline are placed at 2 MOA increments so that you can easily confirm the wind’s influence on the bullet’s impact down-range. The floating center point of aim provides a precise hold on the most difficult targets.



@3,6x

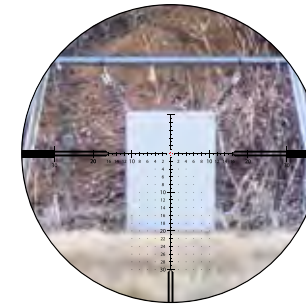

@18x



@5x



@25x

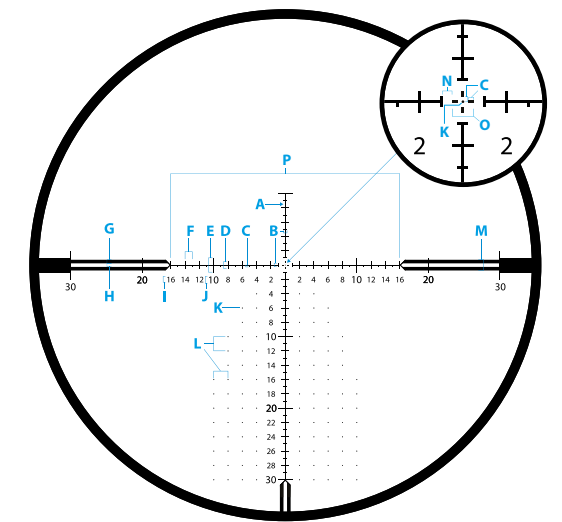

Image above is for illustration purposes.

LRP S5	318-50	525-56		
Unit of measure	MoA		Standard number size I	0.75
Line thickness A	0.125	0.1	10, 20, 30 number size J	1.0
Distance B	0.5		Dot size K	0.125
Distance C	0.25		Dot spacing L	2.0
Distance D	1.0		Distance M	1.5
Distance E	2.0		Spacing around center crosshairs N	0.5
Distance F	1.0		Distance O	1.0
Distance G	0.5		Distance P	32
Distance H	0.5		Distance Q	2.0
			Distance R	3.0
			Distance S	4.0

TECHNICAL SPECIFICATIONS.

Riflescopes	LRP S5	
	318-50	525-56
Model		
Light transmission	90 %	
Magnification	3.6× – 18×	5× – 25×
Reticle focal plane	First focal plane (FFP)	
Effective lens diameter	50 mm	56 mm
Exit pupil diameter	9.3 – 2.8 mm	9.2 – 2.4 mm
Twilight factor	13.4 – 30	16.7 – 37.4
Field of view (100 m)	10.0 – 2.0 m / 100 m	7.5 – 1.5 m / 100 m
Objective viewing angle	5.7° – 1.1°	4.3° – 0.8°
Diopter adjustment range	+2 / -3 D	
Eye relief	90 mm	
Parallax setting	25 – ∞ m	
Vertical adjustment range at 100 m	40.7 MRAD / 140 MOA	
Windage adjustment range at 100 m	17.45 MRAD / 60 MOA	
Adjustment per click at 100 m	0.1 MRAD / 0.25 MOA	
Centre tube diameter	34 mm	
Eyepiece tube diameter	46 mm	
Lens tube diameter	56 mm	62 mm
Lens thread	M54 × 0.75 mm	M60 × 0.75 mm
Coating	LotuTec® and T*	
Nitrogen filling	Yes	
Watertightness	400 mbar	
Operating temperature	-25 °C / +55 °C	
Length	331 mm	396 mm
Weight	930 g	1,030 g
Reticles	ZF-MRi (milliradian) / ZF-MOAI (minute of angle)	

TECHNICAL SPECIFICATIONS.



Riflescopes	LRP S5		
	Model	318-50	525-56
Order no.	MRAD	52 22 75-9916-090	52 22 95-9916-090
	MoA	52 22 65-9917-090	52 22 85-9917-090

Subject to changes in design and scope of delivery as a result of ongoing technical development.

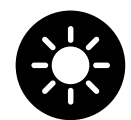
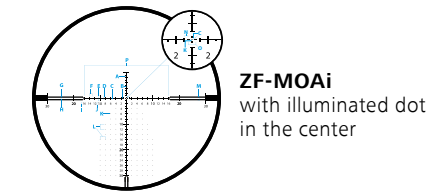
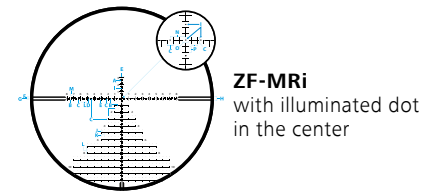

Light transmission



Optical quality



Ballistic stop



Operating the illuminated dot



Reticles



Mounting



Precision shooting



Target shooting



Long-range shooting



Long-range hunting

ZEISS LRP S5

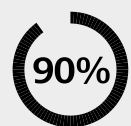

Standard feature
↓
All-metal design
Multiple revolutions
Optimized engraving
Absolute return to zero
↓
Minute of angle (MOA)
Milliradian (MRAD)

Digital technology
Brightness continuously adjustable
Tilt sensor – illuminated dot switched off when setting or laying down the weapon
Automatic shutoff after 4 hours

First focal plane
↓
Smart reticles
↓
ZF-MOAI
ZF-MRi

34 mm rings

Main use

LRP S5 318-50

LRP S5 525-56

BINOCULARS FROM ZEISS

AN UNPARALLELED VIEW. WITH OUR BINOCULARS.

Binoculars from ZEISS have a reputation that precedes them. Their optical performance, ease of use, ruggedness, optimized weight and ongoing technical innovations that have continually pushed the boundaries of what is possible have continued to shape this reputation over the years.

So it is no wonder generations of nature lovers swear by “their” ZEISS binoculars. They have become a reliable companion on countless tours and unique experiences, and are often passed down from generation to generation – along with the stories they have told. Many “historic” ZEISS binoculars are still in daily use today. But time doesn’t stand still.

Today, ZEISS offers devices of outstanding quality for a plethora of requirements, from special binoculars for hunting at night to compact binoculars for daily use.

Learn more about the unique benefits of our various binoculars, their areas of specialty, and their performance on the following pages.

Further information is available on our website at www.zeiss.com/hunting/binoculars



Binoculars from ZEISS feature a wide range of advanced technologies and innovations. The following pages explain which products offer which specific features and benefits in detail. Here’s an initial overview:

HIGH TRANSMISSION VALUES

Always the right binoculars – even in poor lighting conditions thanks to our HT Concept with up to 95 % light transmission.

WEATHER RESISTANCE

Nature observation in any weather thanks to the LotuTec® coating.

RUGGED DESIGN

Reliable on-the-go use with durable materials like a magnesium housing and features like the TripleLink bridge.

OUTSTANDING ERGONOMICS

Fatigue-free observation thanks to our SmartFocus Concept, ErgoBalance Concept, and ComfortFocus Concept.

UNFORGETTABLE EXPERIENCES

Exceptional visual quality and optical clarity thanks to innovative technologies such as our UFL Concept, ZEISS FieldFlattener technology, and T* multicoating.

A PERFECT OVERVIEW

Impressively wide fields of view.



SMART FOCUS WITH SUPERIOR FIELD OF VIEW. VICTORY SF

Victory SF binoculars from ZEISS allow you to experience the most exciting hunting moments.

ZEISS Victory SF binoculars are the most versatile premium binoculars in the 175-year history of ZEISS. Their optical perfection, impressive field of view, revolutionary ergonomics, and lightweight design make Victory SF binoculars extremely versatile for use in any conditions. In other words, they are an expression of everything that ZEISS stands for: unparalleled leading-edge optics.

SmartFocus Concept

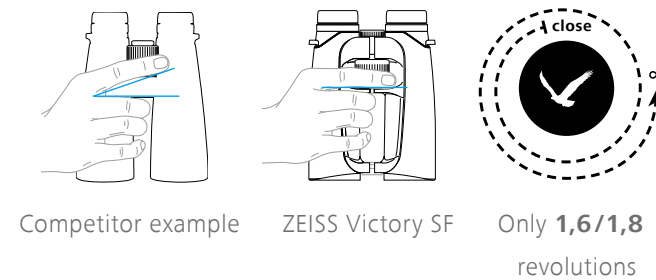

The SmartFocus Concept ensures that the focusing wheel is perfectly positioned. This ensures that you can focus quickly and precisely, even when observing for hours on end.

Fast focusing

SmartFocus Concept for intuitive, precise, rapid focusing thanks to an ergonomic finger position.

Extremely wide field of view

The impressively wide fields of view of both SF models give you a good overview in unclear terrain and help you find exactly the target you are looking for.



Perfect ergonomics

The SF models' center of gravity has been shifted closer to the eyepiece thanks to the ErgoBalance Concept, allowing for long and fatigue-free observation.

Exceptional viewing experience

The UFL Concept combines selected premium lenses with high-quality fluoride glass into a system that delivers extremely lifelike images and vibrant details.

HUNTING OBSERVATION – MADE EASY. VICTORY SF 32.



90%
Light transmission

UFL HT FF T₃

See more than others.

- An extremely wide field of view enlarges the observable area by up to 20% and thus up to 155 meters at a distance of 1,000 meters.
- 90% light transmission.
- Vibrant details and lifelike images thanks to the UFL Concept.
- Compact design and ErgoBalance Concept for long and comfortable nature observation.
- Weighing just 600 grams, much lighter than other binoculars.



SF 8/10×32

The SF 32 models feature vibrant, true-to-life color rendering, an extended field of view, and an ergonomic design for longer, fatigue-free viewing.

UFL HT FF T₃

IDEAL VISIBILITY INTO THE TWILIGHT HOURS. VICTORY SF 42.



92%
Light transmission

UFL HT FF T₃



SF 8/10×42

In addition to outstanding optical performance, the SF 42 model offers perfect ergonomics – the focusing wheel, which is perfectly positioned thanks to the SmartFocus Concept, enables fast and precise focusing.

UFL HT FF T₃

The best for every situation.

- 92% light transmission.
- Vibrant details thanks to the UFL Concept.
- Exceptionally wide field of view of up to 148 meters at a distance of 1,000 meters.
- ZEISS FieldFlattener technology: extreme edge sharpness, even at wide fields of view.
- Perfect ergonomics and ruggedness thanks to TripleLink bridge and lightweight design with state-of-the-art magnesium materials.
- Minimum object distance of 1.5 meters for exploring the smallest details.

VICTORY SF AND SFL.

DISCOVER **MORE** AND EXPERIENCE **LONGER**.

Superior field of view

Extremely wide field of view compared to many competitors for an even better overview in the field.



Increases the observable range by up to 20% compared to other binoculars



ErgoBalance Concept

Ideally balanced for long, steady viewing with less strain on the upper and lower arm muscles.

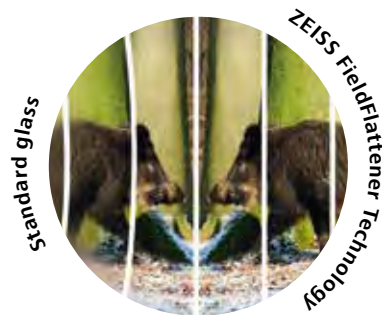
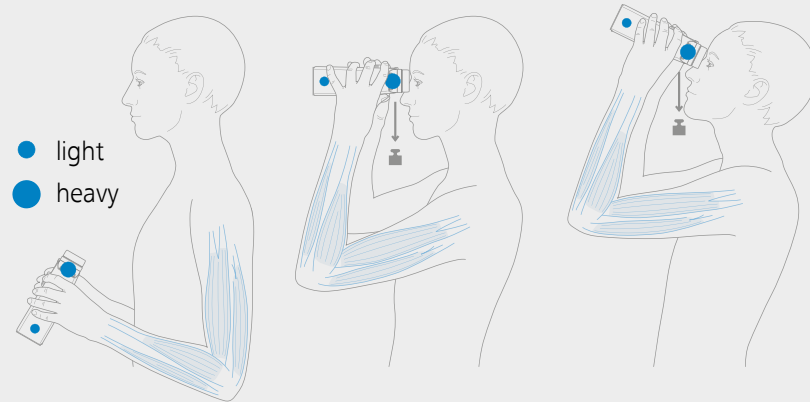

ZEISS FieldFlattener Technology

Extreme edge sharpness even at wide fields of view.

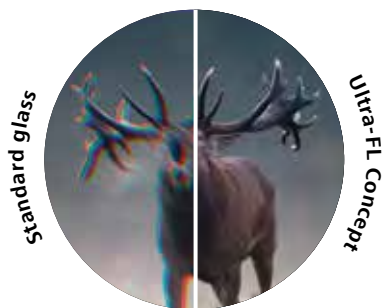

Ultra-FL Concept

Vibrant details and lifelike images thanks to a system of selected premium lenses and high-quality fluoride glass.



Standard glass

SCHOTT
HT GLASS

HT Concept

High-transmission SCHOTT glass for optimal visibility in low light.

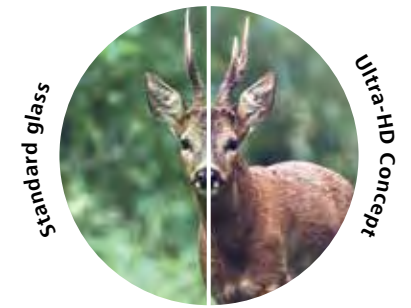

Ultra-HD Concept

Maximum detail visibility and color fidelity thanks to optimizations in coating and optical design.



LotuTec®

Dirt-repellent and extremely easy-to-clean lenses.

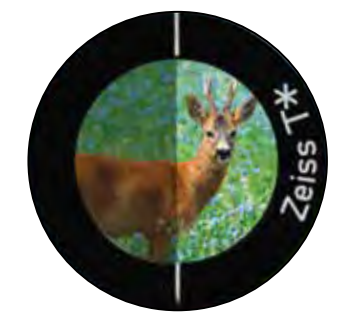

T* Multi-layer coating

Multi-layer coating for sharp and high-contrast viewing.



ZEISS Victory SF	✓	✓	✓	✓	✓	—	✓	✓
ZEISS SFL	✓	—	✓	—	—	✓	✓	✓



SMART FOCUSING AND LIGHTWEIGHT. ZEISS SFL

The new ZEISS SFL binoculars make it possible to experience exciting hunting moments with a new level of ease. Optimized for a light weight and compact size in every aspect and available in two different models, they perfectly complement the other binoculars in the ZEISS SF family.

The new UHD Concept for natural colors, the unique ergonomics, and the SmartFocus Concept ensure the binoculars deliver outstanding visual quality and an immersive viewing experience. The lightweight magnesium housing ensures that the binoculars are durable and long-lasting – for generations to come.

Extremely lightweight



The reduced lens diameter and more compact arrangement of even thinner lens elements make the SFL models **up to 30% lighter** than comparable binoculars.

SmartFocus Concept

The perfectly positioned focusing wheel allows you to focus quickly and precisely – without having to spread your fingers apart.



Up to 30% less weight than comparable competitors



Standard glass

Ultra-HD Concept

Ultralight, compact design

The lightweight magnesium body and reduced lens diameter combined with the closer spacing make the SFL 19% lighter and 17% shorter than the Victory SF 42.

Perfect ergonomics

The large exit pupil allows users to quickly and easily position their eye for a comfortable and immersive viewing experience. Improved eyecups for an even better ergonomic feel.

Superior optical performance

The new UHD Concept delivers maximum detail visibility and color fidelity thanks to optimized coating and optical design.



SUCCESSFUL BUCK HUNTING. VICTORY SF AND SFL THE BEST FOR EVERY SITUATION.

In addition to hunting skills and good preparation, choosing the right equipment plays an essential role in successful hunting. The size and weight of the equipment play a critical role in your ability to successfully stalk game.

Compact binoculars like the Victory SF and SFL models offer a clear advantage in this regard, because thanks to their perfect ergonomics, you can focus entirely on the hunt – and not on your equipment.



PRODUCT PROFILE

HUNTING HAS NEVER BEEN EASIER. ZEISS SFL 40.



82
83



SFL 8 / 10 x 40

The perfect ergonomics of the SFL 40 models, the ultralight design, the UHD Concept, and the SmartFocus Concept make handling easy and precise while still providing the highest level of detail recognition, even when observing for hours on end.



Carefree observation.

- A viewing experience rich in detail with natural colors thanks to the UHD Concept.
- 90 % light transmission.
- The large exit pupil allows users to quickly and easily position their eye for a comfortable and immersive viewing experience.
- Ultralight, compact design featuring the SmartFocus Concept.
- A clear view at all times thanks to our LotuTec® coating.

COMPARISON OF VICTORY SF AND SFL.

	Main use			
	Outdoor/ recreation	Stalking	Birding/ nature observation	High seat/ night
Light transmission Optical quality 				
ZEISS Victory SF SF 42 SF 32 			SF 8×42 SF 10×42 SF 8×32 SF 10×32	
ZEISS SFL 			SFL 8×40 SFL 10×40	
ZEISS Victory HT 			HT 8×54 HT 10×54	
ZEISS Victory Pocket 	Pocket 8×25 Pocket 10×25			
ZEISS Conquest HD 			HD 8×42 HD 10×42 HD 8×32 HD 10×32	
ZEISS Terra ED / Pocket 	ED 8×42 ED 10×42 ED 8×32 ED 10×32 Pocket 8×25 Pocket 10×25			

*Hydrophobic and antireflective coating.



TECHNICAL SPECIFICATIONS.

Victory binoculars Model	SF				SFL	
	8×32	10×32	8×42	10×42	8×40	10×40
Light transmission	90 %		92 %		90 %	
Magnification	8×	10×	8×	10×	8×	10×
Lens diameter	32 mm		42 mm		40 mm	
Exit pupil diameter	4 mm	3.2 mm	5.3 mm	4.2 mm	5 mm	4 mm
Twilight factor	16	17.9	18.3	20.5	17.9	20
Field of view (1,000 m)	155 m	130 m	148 m	120 m	140 m	115 m
Angular field of view, real	67°	69°	64°		60°	62°
MOD	1.95 m		1.5 m		1.5 m	
Diopter adjustment range	+/-4 D				+/-4 D	
Exit pupil distance	19 mm		18 mm		18 mm	
Interpupillary distance	54–76 mm		55–76 mm		52–74 mm	
Lens type	UFL		UFL		UHD	
Prism system	Schmidt-Pechan		Schmidt-Pechan		Schmidt-Pechan	
Coating	LotuTec®				LotuTec®	
Nitrogen filling	Yes				Yes	
Watertightness	400 mbar				400 mbar	
Operating temperature	-30 °C/+63 °C				-20 °C/+55 °C	
Length	152 mm	150 mm	173 mm		144 mm	
Width at an interpupillary distance of 65 mm	112 mm		125 mm		114 mm	
Weight	600 g	590 g	790 g		640 g	
Order no.	52 32 24	52 32 25	52 42 23	52 42 24	52 40 23	52 40 24

Subject to changes in design and scope of delivery as a result of ongoing technical development. More information can be found online at www.zeiss.com/consumer-products

ACCESSORIES



Air Cell Comfort Straps

The carrying strap makes carrying binoculars with a lens diameter of 30 mm or more much more comfortable. The enclosed air cushions increase carrying comfort. Quick-release fasteners allow you to quickly attach and detach the carrying strap. The length of the strap is fully adjustable.



Comfort Cross Straps

The cross straps made of high-quality materials reduce neck strain and distribute the weight of the binoculars across the upper body. The binoculars remain steady and do not swing in different directions when you are moving. The binoculars can be easily locked in place and are very comfortable to carry at the same time.



MAXIMUM TRANSMISSION AND MAGNIFICATION.

VICTORY HT

VICTORY HT premium binoculars allow you to experience hunting in a whole new dimension.

HT Concept

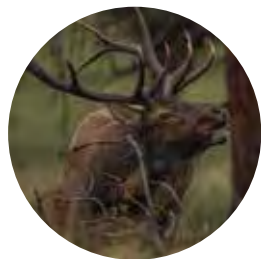

Standard glass

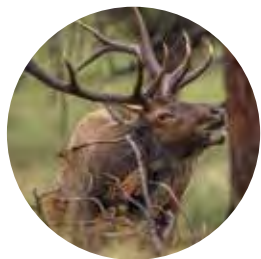

SCHOTT HT GLASS

High-transmission SCHOTT lenses for optimal visibility in twilight and at night.



Thanks to a revolutionary optical concept, they stand out with light transmission values of 95 % and more. This is an unparalleled value that is achieved through the perfect combination of SCHOTT HT lenses, ZEISS T* multicoating, and the Abbe-König prism system and guarantees maximum brightness. This allows you to observe decisively longer on the hunt and also safely identify your target – even in the deepest twilight.

The ComfortFocus Concept stands out thanks to its extremely precise focusing with a large focusing wheel embedded in the Double-Link bridge. This makes it extremely rugged, extremely easy to operate, and extremely durable. Experience cutting-edge optics – with the brightest binoculars from ZEISS.

Design based on tradition

The elegant design marks the continuation of the ZEISS Dialyt design – timeless and functional.

Form follows intuition

Maximum precision when focusing thanks to the ComfortFocus Concept. The conspicuously large focusing wheel and the deliberately long gear ratio make it possible to focus extremely precisely – even when wearing gloves.



Extremely durable

The use of extremely solid, super-light magnesium guarantees maximum service life.

Light in the darkness

The combination of SCHOTT HT glass, ZEISS T* multicoating, and the Abbe-König prism system results in light transmission of 95 % and more.



FOR TWILIGHT AND AT NIGHT. VICTORY HT.



95%
Light transmission

HT FL T_i

Designed for twilight.

- High-transmission SCHOTT glass achieves a light transmission rate of 95 % and offers optimum visibility in low light conditions.
- FL glass produces natural colors, thereby enhancing imaging performance.
- Thanks to the large focusing wheel, the ComfortFocus Concept maximizes focusing precision, even when wearing gloves.
- Low weight and a modern design for unparalleled ergonomics.



ZEISS IN THE FIELD



HT 8/10 × 54

The HT 54 models are among the best performing binoculars from ZEISS for observation during twilight and at night. Thanks to a light transmission value of 95 %, maximum performance in low light is guaranteed. In addition, the 8 × 54 stands out due to its outstanding ergonomics and large exit pupil.

HT FL T_i



Care tips from ZEISS

The LotuTec® coating is both durable and abrasion-resistant, and its special surface creates a beading effect that makes cleaning the lens easier. We recommend using a ZEISS lens cleaning cloth to clean the lens surface. Do not wipe off coarse particles on the lenses, such as sand. Instead, wash them off or remove them with a lens brush.

COMPARISON OF VICTORY HT MODELS.

	Light transmission	Optical quality	Main use				
			Outdoor/recreation	Stalking	Birding/nature observation	High seat/night	
ZEISS Victory SF	92% SF 42	90% SF 32		SF 8×42 SF 10×42 SF 8×32 SF 10×32			
ZEISS SFL	90%			SFL 8×40 SFL 10×40			
ZEISS Victory HT	95%					HT 8×54 HT 10×54	
ZEISS Victory Pocket	91%			Pocket 8×25 Pocket 10×25			
ZEISS Conquest HD	90%			HD 8×42 HD 10×42 HD 8×32 HD 10×32		HD 8×56 HD 10×56 HD 15×56	
ZEISS Terra ED / Pocket	88%			ED 8×42 ED 10×42 ED 8×32 ED 10×32 Pocket 8×25 Pocket 10×25			

*Hydrophobic and antireflective coating.



TECHNICAL SPECIFICATIONS.

Victory binoculars	HT	
	8×54	10×54
Model		
Light transmission	95 %	
Magnification	8×	10×
Lens diameter	54 mm	
Exit pupil diameter	6.7 mm	5.4 mm
Twilight factor	20.7	23.2
Field of view (1,000 m)	130 m	110 m
Angular field of view, real	60°	63°
MOD	3.5 m	
Diopter adjustment range	+/-3 D	
Exit pupil distance	16 mm	
Interpupillary distance	58–76 mm	
Lens type	FL/HT type	
Prism system	Abbe-König	
LotuTec®/Nitrogen filling	Yes/Yes	
Waterproof	500 mbar	
Operating temperature	-30/+63 °C	
Length	193 mm	
Width at an interpupillary distance of 65 mm	142 mm	
Weight	1,035 g	1,050 g
Order no.	52 56 28	52 56 29

Subject to changes in design and scope of delivery as a result of ongoing technical development. More information can be found online at www.zeiss.com/consumer-products

ACCESSORIES



Air Cell Comfort Straps

The carrying strap makes carrying binoculars with a lens diameter of 30 mm or more much more comfortable. The enclosed air cushions increase carrying comfort. Quick-release fasteners allow you to quickly attach and detach the carrying strap. The length of the strap is fully adjustable.



Comfort Cross Straps

The cross straps made of high-quality materials reduce neck strain and distribute the weight of the binoculars across the upper body. The binoculars remain steady and do not swing in different directions when you are moving. The binoculars can be easily locked in place and are very comfortable to carry at the same time.



A POCKET-SIZED PREMIUM OPTICAL DEVICE.

VICTORY POCKET

Whether on a tour of the hunting grounds or on a spontaneous hunting trip, there's always something to discover and observe. That's why it's also a good idea to always have a pair of binoculars in your pocket. The ZEISS Victory Pocket binoculars are the perfect companions in these situations.

The Victory Pocket is a featherweight, versatile pair of pocket-sized, high-performance binoculars from ZEISS for almost any observation situation. Thanks to the binoculars' compact and lightweight format, they even fit into smaller pockets and are hardly noticeable thanks to their light weight.

With high magnification at an amazingly low weight and FL lenses with ZEISS T* multicoating, the Victory Pocket models deliver impressively clear views. Asymmetrical folding makes them particularly compact and the LotuTec® coating ensures that water beads off and dirt can be removed easily.



Pocket 8/10 x 25

Tried-and-tested high-performance binoculars for virtually any observing situation. Due to the binoculars' compact size and light weight, they can even be carried comfortably in smaller jacket pockets.



PERFECT FOR WHEN ON THE GO.



Compact folding

Asymmetrical bridge for quick adjustment, perfect stability, and compact storage.

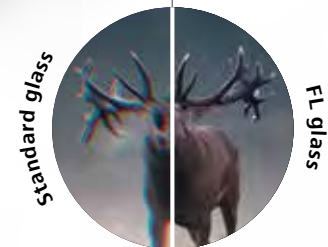
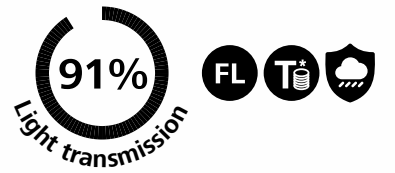
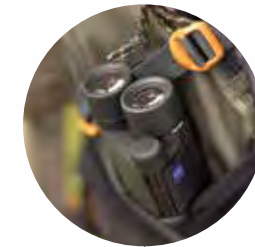

Rugged design

Thanks to its modern and rugged design, the Victory Pocket can be taken anywhere and handles many situations.

Vibrant

Large field of view, FL glass, and T* multicoating for vibrant and high-contrast images.



COMPARISON OF VICTORY POCKET MODELS.

	Light transmission	Optical quality	Main use				
			Outdoor/recreation	Stalking	Birding/nature observation	High seat/night	
ZEISS Victory SF	92% SF 42	90% SF 32		SF 8×42 SF 10×42 SF 8×32 SF 10×32			
ZEISS SFL	90%			SFL 8×40 SFL 10×40			
ZEISS Victory HT	95%					HT 8×54 HT 10×54	
ZEISS Victory Pocket	91%			Pocket 8×25 Pocket 10×25			
ZEISS Conquest HD	90%			HD 8×42 HD 10×42 HD 8×32 HD 10×32		HD 8×56 HD 10×56 HD 15×56	
ZEISS Terra ED / Pocket	88%			ED 8×42 ED 10×42 ED 8×32 ED 10×32 Pocket 8×25 Pocket 10×25			

*Hydrophobic and antireflective coating.

TECHNICAL SPECIFICATIONS.



Victory binoculars Model	Pocket	
	8×25	10×25
Light transmission	91%	
Magnification	8×	10×
Lens diameter	25 mm	25 mm
Exit pupil diameter	3.1 mm	2.5 mm
Twilight factor	14.1	15.8
Field of view (1,000 m)	130 m	105 m
Angular field of view	60°	
Close focusing distance	1.9 m	
Diopter adjustment range	±3 D	
Exit pupil distance	16.5 mm	
Interpupillary distance	34–74 mm	
Lens type	FL	
Prism system	Schmidt-Pechan	
LotuTec®/Nitrogen filling	Yes/Yes	
Waterproof	100 mbar	
Operating temperature	-25/+63 °C	
Length	112 mm	
Width at an interpupillary distance of 65 mm	100 mm	
Weight	290 g	
Order no.	52 20 38	52 20 39

Subject to changes in design and scope of delivery as a result of ongoing technical development. More information can be found online at www.zeiss.com/consumer-products

ZEISS IN THE FIELD



Care tips from ZEISS

The LotuTec® coating is both durable and abrasion-resistant, and its special surface creates a beading effect that makes cleaning the lens easier. We recommend using a ZEISS lens cleaning cloth to clean the lens surface. Do not wipe off coarse particles on the lenses, such as sand. Instead, wash them off or remove them with a lens brush.

ACCESSORIES

AntiFOG Kit

ZEISS AntiFOG spray is applied gently and quickly to the lens of your binoculars, riflescopes, or spotting scopes. The result; the lens remains fog free for up to 72 hours – without interfering with its optical quality. In order to ensure that ZEISS AntiFOG achieves the best results, the lens should first be cleaned with the included ZEISS lens cleaning wipe. This makes it easy to maintain a crystal clear view, even in extremely humid conditions.





AN ALL-AROUND TALENT IN HIGH DEFINITION. CONQUEST HD

The balanced Conquest HD binoculars offer excellent performance for an impressive hunting experience.

Thanks to its compact dimensions, light weight, and modern, rugged design, the Conquest HD makes comfortable observation possible in almost any conditions. Uncompromising design, ergonomics, and optical quality at an incredibly attractive price.

LotuTec®



Even in wet weather, there are impressive things to see during the hunt. ZEISS developed LotuTec® precisely for this purpose. This is a coating on the lenses that provides unobstructed visibility in all weather conditions.

Rugged design

Compact dimensions, low weight, and rugged body design ensure the binoculars are ready for use in all conditions.

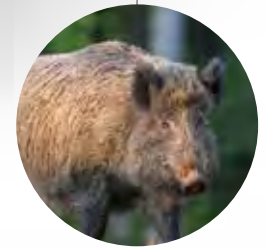
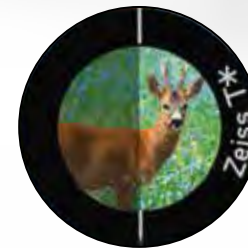

High-contrast and vibrant

T* multicoating for vibrant and high-contrast images.



Optimized control elements

The slightly slanted eyecups fit perfectly and thus enhance ergonomics and viewing comfort.

Nature in HD

High-resolution images and fine sharpness – experience optical devices that set standards thanks to the use of high-definition glass.



IMPRESSIVE DOWN TO THE SMALLEST DETAIL. CONQUEST HD.

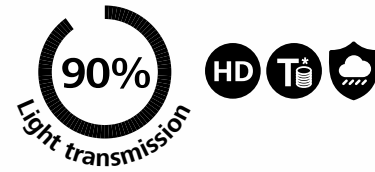

Conquer the outdoors in high definition.

- High-resolution images and fine sharpness thanks to high-definition glass.
- Compact dimensions, low weight, and modern design for unparalleled ergonomics.
- High light transmission values for impressive observations in twilight.
- Simple, intuitive operation.



HD 8/10×32

The compact design and low weight make the Conquest HD 8/10×32 a comfortably portable yet powerful companion with an extra-wide field of view thanks to the HD lens system.



HD 8/10×42

Made in Germany with extremely high standards of quality. Ideal for users looking for sharp, natural color rendering and outstanding quality at close range.



ZEISS IN THE FIELD



HD 8/10/15×56

This version is a specialist for difficult lighting conditions and stands out with sharp, high-contrast views. A tripod adapter is included with the 15×56.



Care tips from ZEISS

The LotuTec® coating is both durable and abrasion-resistant, and its special surface creates a beading effect that makes cleaning the lens easier. We recommend using a ZEISS lens cleaning cloth to clean the lens surface. Do not wipe off coarse particles on the lenses, such as sand. Instead, wash them off or remove them with a lens brush.

COMPARISON OF CONQUEST HD MODELS.

	Main use			
	Outdoor/ recreation	Stalking	Birding/ nature observation	High seat/ night
Light transmission Optical quality 				
ZEISS Victory SF SF 42 SF 32 UFL, HT, FF, T			SF 8×42 SF 10×42 SF 8×32 SF 10×32	
ZEISS SFL UHD, FF, T			SFL 8×40 SFL 10×40	
ZEISS Victory HT HT, FL, T				HT 8×54 HT 10×54
ZEISS Victory Pocket FL, T			Pocket 8×25 Pocket 10×25 	
ZEISS Conquest HD HD, T			HD 8×42 HD 10×42 HD 8×32 HD 10×32 	HD 8×56 HD 10×56 HD 15×56
ZEISS Terra ED / Pocket ED, T			ED 8×42 ED 10×42 ED 8×32 ED 10×32 Pocket 8×25 Pocket 10×25 	

*Hydrophobic and antireflective coating.

TECHNICAL SPECIFICATIONS.

Conquest binoculars Model	HD						
	8×32	10×32	8×42	10×42	8×56	10×56	15×56
Light transmission	90 %		90 %		90 %		
Magnification	8×	10×	8×	10×	8×	10×	15×
Effective lens diameter	32 mm	32 mm	42 mm	42 mm	56 mm	56 mm	56 mm
Exit pupil diameter	4 mm	3.2 mm	5.25 mm	4.2 mm	7 mm	5.6 mm	3.7 mm
Twilight factor	16	17.9	18.3	20.5	21.2	23.7	29.0
Field of view (1,000 m)	140 m	118 m	128 m	115 m	125 m	115 m	80 m
Angular field of view, real	64°	68°	59°	66°	57°	66°	69°
MOD	1.5 m		2 m		3.5 m		
Diopter adjustment range	+/-4 D		+/-4 D		+/-4 D		
Exit pupil distance	16 mm		18 mm		18 mm		
Interpupillary distance	54–74 mm		54–74 mm		54–74 mm		
Lens type	HD		HD		HD		
Prism system	Schmidt-Pechan		Schmidt-Pechan		Abbe-König		
Coating	LotuTec®/T*		LotuTec®/T*		LotuTec®/T*		
Nitrogen filling	Yes		Yes		Yes		
Watertightness	400 mbar		400 mbar		400 mbar		
Operating temperature	-20/+63 °C		-20/+63 °C		-20/+63 °C		
Length	132 mm		150 mm		210 mm		
Width at an interpupillary distance of 65 mm	118 mm		120 mm		145 mm		
Weight	630 g	630 g	795 g	795 g	1,265 g	1,275 g	1,295 g
Order no.	52 32 11	52 32 12	52 42 11	52 42 12	52 56 31	52 56 32	52 56 33

Subject to changes in design and scope of delivery as a result of ongoing technical development. More information can be found online at www.zeiss.com/consumer-products

ACCESSORIES



Air Cell Comfort Straps

The carrying strap makes carrying binoculars with a lens diameter of 30 mm or more much more comfortable. The enclosed air cushions increase carrying comfort. Quick-release fasteners allow you to quickly attach and detach the carrying strap. The length of the strap is fully adjustable.



Comfort Cross Straps

The cross straps made of high-quality materials reduce neck strain and distribute the weight of the binoculars across the upper body. The binoculars remain steady and do not swing in different directions when you are moving. The binoculars can be easily locked in place and are very comfortable to carry at the same time.



FOR DEMANDING **ENTHUSIASTS.**
TERRA ED

With its fiberglass-reinforced and waterproof housing, the ZEISS Terra ED will even satisfy hunters with the highest standards.

Its low weight makes the Terra ED a perfect companion that fits comfortably in any pocket. It features a compact, lightweight, and rugged design. Time-tested ZEISS quality delivers an outstanding observation experience, even under adverse conditions.

ZEISS IN THE FIELD



Thanks to the use of high-quality materials, ZEISS optical devices are always ready for use – even under extreme conditions. Binoculars and spotting scopes from ZEISS are 100 % waterproof and nitrogen-filled, which prevents fogging from the inside, even during extreme temperature changes. The rubber armoring makes them rugged as well as shockproof and provides initial protection for the high-performance lenses inside the devices. This is how optical devices are created that can always be relied on.

Compact and lightweight

Terra ED binoculars stand out for their modern design and are both lightweight and comfortably compact thanks to their slim design.



A clear view in any weather

The ZEISS hydrophobic antireflective coating in combination with ED glass guarantees true-color images in any weather conditions.



COMPACT ZEISS QUALITY. TERRA ED.

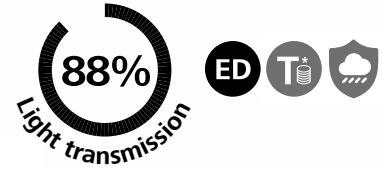

Perfect for when on the go.

- Smooth and easy-to-grip focusing wheel for particularly simple and fast focusing.
- Fiberglass-reinforced and waterproof housing for rugged environments.
- ED glass and the hydrophobic multicoating deliver true-color images.



ED Pocket 8/10×25

The Terra ED Pocket is extremely compact and lightweight, delivers outstanding visual quality in its class, and stands out due to its user-friendly operation.



ED 8/10×32

Impressive optical performance, precise focusing, and a compact design are the hallmarks of the 32 mm version of the Terra ED.



ED 8/10×42

The Terra ED 42 features a bright viewing experience that is rich in detail as well as outstanding ease of use.



COMPARISON OF TERRA ED MODELS.

	Main use			
	Outdoor/ recreation	Stalking	Birding/ nature observation	High seat/ night
ZEISS Victory SF Light transmission: 92% (SF 42), 90% (SF 32) Optical quality: UFL, HT, FF, T ⁺	SF 8×42 SF 10×42 SF 8×32 SF 10×32			
ZEISS SFL Light transmission: 90% Optical quality: UHD, FF, T ⁺	SFL 8×40 SFL 10×40			
ZEISS Victory HT Light transmission: 95% Optical quality: HT, FL, T ⁺			HT 8×54 HT 10×54	
ZEISS Victory Pocket Light transmission: 91% Optical quality: FL, T ⁺	Pocket 8×25 Pocket 10×25			
ZEISS Conquest HD Light transmission: 90% Optical quality: HD, T ⁺	HD 8×42 HD 10×42 HD 8×32 HD 10×32		HD 8×56 HD 10×56 HD 15×56	
ZEISS Terra ED / Pocket Light transmission: 88% Optical quality: ED, T ⁺	ED 8×42 ED 10×42 ED 8×32 ED 10×32 Pocket 8×25 Pocket 10×25			

*Hydrophobic and antireflective coating.



TECHNICAL SPECIFICATIONS.

Terra binoculars Model	ED					
	8×25	10×25	8×32	10×32	8×42	10×42
Light transmission	88%		88%		88%	
Magnification	8×	10×	8×	10×	8×	10×
Lens diameter	25 mm		32 mm		42 mm	
Exit pupil diameter	3.1 mm	2.5 mm	4 mm	3.2 mm	5.3 mm	4.2 mm
Twilight factor	14.1	15.8	16	17.9	18.3	20.5
Field of view (1,000 m)	119 m	97 m	135 m	112 m	125 m	110 m
Angular field of view	52°	54°	61°	61°	56°	60°
Close focusing distance	1.9 m		1.6 m		1.6 m	
Diopter adjustment range	±3 D		±3 D		±3 D	
Exit pupil distance	16 mm		16.5 mm		18 mm	14 mm
Interpupillary distance	35–72 mm		56–74 mm		58–75.5 mm	
Lens type	ED		ED		ED	
Prism system	Schmidt-Pechan		Schmidt-Pechan		Schmidt-Pechan	
Coating	Hydrophobic ZEISS MC		Hydrophobic ZEISS MC		Hydrophobic ZEISS MC	
Nitrogen filling	Yes		Yes		Yes	
Watertightness	100 mbar		100 mbar		100 mbar	
Operating temperature	-20/+63 °C		-15/+60 °C		-15/+60 °C	
Length	111 mm		125 mm		142 mm	
Width at an interpupillary distance of 65 mm	115 mm		117 mm		120 mm	
Weight	310 g		510 g		725 g	
Order no.	black / green		52 32 03-99 08	52 32 04-99 08	52 42 03-99 08	52 42 04-99 08
	black / black	52 25 02-99 01	52 25 03-99 01	52 32 03-99 01	52 32 04-99 01	52 42 03-99 01
	black / gray	52 25 02-99 07	52 25 03-99 07	52 32 03-99 07	52 32 04-99 07	52 42 03-99 07

Subject to changes in design and scope of delivery as a result of ongoing technical development. More information can be found online at www.zeiss.com/consumer-products

ACCESSORIES



Air Cell Comfort Straps

The carrying strap makes carrying binoculars with a lens diameter of 30 mm or more much more comfortable. The enclosed air cushions increase carrying comfort. Quick-release fasteners allow you to quickly attach and detach the carrying strap. The length of the strap is fully adjustable.



Comfort Cross Straps

The cross straps made of high-quality materials reduce neck strain and distribute the weight of the binoculars across the upper body. The binoculars remain steady and do not swing in different directions when you are moving. The binoculars can be easily locked in place and are very comfortable to carry at the same time.



TRANSFORMING INTUITION INTO **CERTAINTY.**

VICTORY RANGEFINDER

Experienced hunters can always rely on their senses. But it takes the right gear to transform intuition into certainty.

The Victory Rangefinder system is a laser rangefinder with integrated real-time ballistic calculator. Taking all relevant factors and individual adaptability into account using the ZEISS Hunting App ensures accurate shots at all distances.

The Victory RF family includes four models: the Victory RF 8×42 and 10×42 for daytime hunting and the Victory RF 8×54 and 10×54 for hunting into the twilight hours.

Bluetooth



At ZEISS, we are never satisfied with the status quo. The RF's software is constantly being enhanced to improve performance even further. With Bluetooth and our ZEISS Hunting App, you can update your Victory RF model to the latest state of development at any time.

PRODUCT PROFILE

CERTAINTY THROUGH LASER MEASUREMENT.



Binocular real-time ballistics system

Equipped with various measurement functions, the Rangefinder takes a variety of relevant data into account and uses it to determine the exact value required to set the ASV for the most accurate results under all environmental conditions.



The right setting

The ability to save up to nine individual ballistic profiles created in the ZEISS Hunting App ensures the binoculars are perfectly adapted to the shooter's needs.



Everything in view

The Rangefinder measures the exact distance to the target with a maximum measuring distance of up to 2,300 meters. The combination of FL glass and ZEISS T* multicoating produces naturally vibrant images.





RF 8/10×42

The Rangefinder model with a compact design. The binocular real-time ballistics system can be synchronized with the ZEISS Hunting App via Bluetooth.



RF 8/10×54

All of the features of the Rangefinder system combined with powerful optics. This model is ideal for all those with high optical standards.



ZEISS IN THE FIELD



Care tips from ZEISS

The LotuTec® coating is both durable and abrasion-resistant, and its special surface creates a beading effect that makes cleaning the lens easier. We recommend using a ZEISS lens cleaning cloth to clean the lens surface. Do not wipe off coarse particles on the lenses, such as sand. Instead, wash them off or remove them with a lens brush.

TECHNICAL SPECIFICATIONS.

Victory Rangefinder System

Model	RF System			
	8×42	10×42	8×54	10×54
Magnification	8×	10×	8×	10×
Effective lens diameter	42 mm		54 mm	
Exit pupil diameter	5.3 mm	4.2 mm	6.8 mm	5.4 mm
Twilight factor	18.3	20.5	20.8	23.2
Field of view	135 m	115 m	120 m	110 m
Angular field of view, real	61°	63°	54°	61°
MOD	2.5 m		3.5 m	
Diopter adjustment range	+/-4 D			
Exit pupil distance	16 mm		14 mm	
Interpupillary distance	53.5 – 76 mm		58.5 – 76 mm	
Lens type	FL			
Prism system	Abbe-König			
Coating	LotuTec®/T*			
Nitrogen filling	Yes			
Watertightness	100 mbar			
Operating temperature	-25 °C / +63 °C			
Length	166 mm		195 mm	
Width at an interpupillary distance of 65 mm	130 mm		141 mm	
Weight	930 g	960 g	1,095 g	1,130 g
Measuring range	10 – 2,300 m			
Measurement accuracy	±1 up to 600 m / ± 0.5% over 600 m			
Measuring time	< 0.3 sec.			
Laser wavelength	905 nm			
Laser beam divergence	1.6 × 0.5 nm			
Battery	1 × lithium round cell 3V type CR 2			
Battery life at +20 °C	>2,500 ×			
Order no.	52 45 48	52 45 49	52 56 48	52 56 49

Subject to changes in design and scope of delivery as a result of ongoing technical development. More information can be found online at www.zeiss.com/consumer-products

ZEISS HUNTING APP



The ability to synchronize the binoculars with the ZEISS Hunting App via Bluetooth perfects the Rangefinder system. The app allows you to transfer your individual ballistics data to the Rangefinder, share it with your friends, and manage your hunting grounds together with fellow hunters.

- News
- Dashboard
- Ballistics
- Hunting diary
- Weather information
- Connected products
- My gear
- Hunting grounds
- Sharing

FOCUSING ON THE ESSENTIALS.

		Benefits		Main use					
Light transmission	Optical quality	Magnification	Ergonomics / technology		Field of view (1,000 m)	Outdoor/recreation	Stalking	Birding/nature observation	High seat/night
ZEISS Victory SF SF 42 SF 32		8x 10x	SmartFocus Concept Only 1.6/1.8 revolutions 	ErgoBalance Concept • light • heavy The center of balance of the optical components is shifted to the rear, allowing for long periods of observation with minimal fatigue.	148 m 120 m 155 m 130 m			SF 8x42 SF 10x42 SF 8x32 SF 10x32	
ZEISS SFL 		8x 10x	SmartFocus Concept Only 1.4 revolutions 	Low weight Reduced weight thanks to a compact lens design, magnesium housing, and a lens diameter reduced by 2 mm.	140 m 115 m			SFL 8x40 SFL 10x40	
ZEISS Victory HT 		8x 10x	ComfortFocus Concept 	Optimized lens diameter Reduced weight thanks to optimized lens diameter.	130 m 110 m			HT 8x54 HT 10x54	
ZEISS Victory Pocket 		8x 10x		Asymmetrical bridge for perfect stability and to quickly set the correct interpupillary distance. Small, handy, and can be stored anywhere thanks to its ultra-compact folding size. Perfect for travel and when out and about.	130 m 105 m	Pocket 8x25 Pocket 10x25			
ZEISS Conquest HD 		8x 10x 15x		Compact dimensions, low weight, and rugged housing design ensure the binoculars are ready for use in all conditions. Optimized and smooth controls – the focus wheel and eyecups are easy to adjust.	125 m 115 m 80 m 128 m 115 m 140 m 118 m			HD 8x56 HD 10x56 HD 15x56 HD 8x42 HD 10x42 HD 8x32 HD 10x32	
ZEISS Terra ED / Pocket 		8x 10x		Compact and lightweight – its small size makes it perfect for travel, observation in the backyard, and while on the go.	125 m 110 m 135 m 112 m 119 m 97 m	ED 8x42 ED 10x42 ED 8x32 ED 10x32 Pocket 8x25 Pocket 10x25			

- HT** **HT Concept**
High-transmission SCHOTT glass for optimal visibility in low light.
- UFL** **Ultra-FL Concept**
System of selected premium lenses made from high-quality fluoride glass for extremely lifelike images and vibrant details.
- FL** **Fluoride Glass**
A natural appearance thanks to fluoride glass from SCHOTT.
- UHD** **Ultra-HD Concept**
Maximum detail visibility and color fidelity thanks to optimizations in coating and optical design.
- HD** **High-Definition Lenses**
For outstanding resolution and fine sharpness.
- ED** **Extra Low-Dispersion Lenses**
For enhanced color fidelity.
- FF** **ZEISS FieldFlattener Technology**
Extreme edge sharpness, even at wide fields of view.
- LotuTec®**
Dirt-repellent and extremely easy-to-clean lenses.
- T+** **T+**
Multi-layer coating for bright, high-contrast images.
- Magnification**
8x: A larger field of view and larger exit pupil enhances twilight visibility.
10x/15x: Enhanced ability to identify fine details.

SPOTTING SCOPES FROM ZEISS

RELIABLY FASCINATING. OUR SPOTTING SCOPES.

Nature is always fascinating, even outside hunting season. Anyone who enjoys being outdoors and observing animals in their natural environment and wants to know their hunting grounds like the back of their hand needs the right, reliable gear for this purpose.

Spotting scopes from ZEISS meet these needs in a variety of ways – with true-to-detail and multifaceted reproduction, wide fields of view, and breathtaking levels of magnification. These are the qualities that make ZEISS spotting scopes popular worldwide and create very special moments in the great outdoors.

Further information is available on our website at www.zeiss.com/hunting/spotting-scopes



Spotting scopes from ZEISS feature a wide range of advanced technologies and innovations. The following pages explain which products offer which specific features and benefits in detail. Here's an initial overview:

UNFORGETTABLE EXPERIENCES

Bright and clear viewing thanks to T* multicoating, the UFL Concept, SCHOTT fluoride glass, and the HD lens system.

EVERYTHING QUICKLY IN VIEW

Comfortable and fast focusing thanks to DualSpeed Focus and the ComfortVision Concept.

EXTREMELY WIDE FIELD OF VIEW

See and discover more with high-resolution lens systems.

WEATHER RESISTANCE

Nature observation in any weather thanks to the LotuTec® coating.

114
115



FROM **MAXIMUM FIELD OF VIEW**
TO **MAXIMUM MAGNIFICATION.**
VICTORY HARPIA

The great outdoors are already truly fascinating when observed with the naked eye. But viewing nature through a Victory Harpia transforms it into an entirely new experience.

This spotting scope offers a new, exceptional lens system with 3x wide-angle zoom and up to 70x magnification with a choice of 85 or 95 mm lens diameter. Extremely wide fields of view are impressive in every situation. DualSpeed Focus enables fast and accurate focusing, even at high magnification.

Whether far away or up close, the unmatched dynamic performance of the Victory Harpia ensures that you remain in command of any unexpected observation situation.

ComfortVision Concept

Exceptionally wide viewing angle from 23x to 70x magnification for a noticeably enhanced overview in the field.



23x/30x

Field of view comparison of a spotting scope at 30x minimum magnification (small circle) with the field of view of the Harpia at 23x minimum magnification (large circle).

PRODUCT PROFILE



EVEN CLOSER
TO THE HUNTING GROUND.

Exceptional viewing experience

The UFL Concept combines several lenses made of SCHOTT fluoride glass into a system that delivers vibrant details and lifelike images.

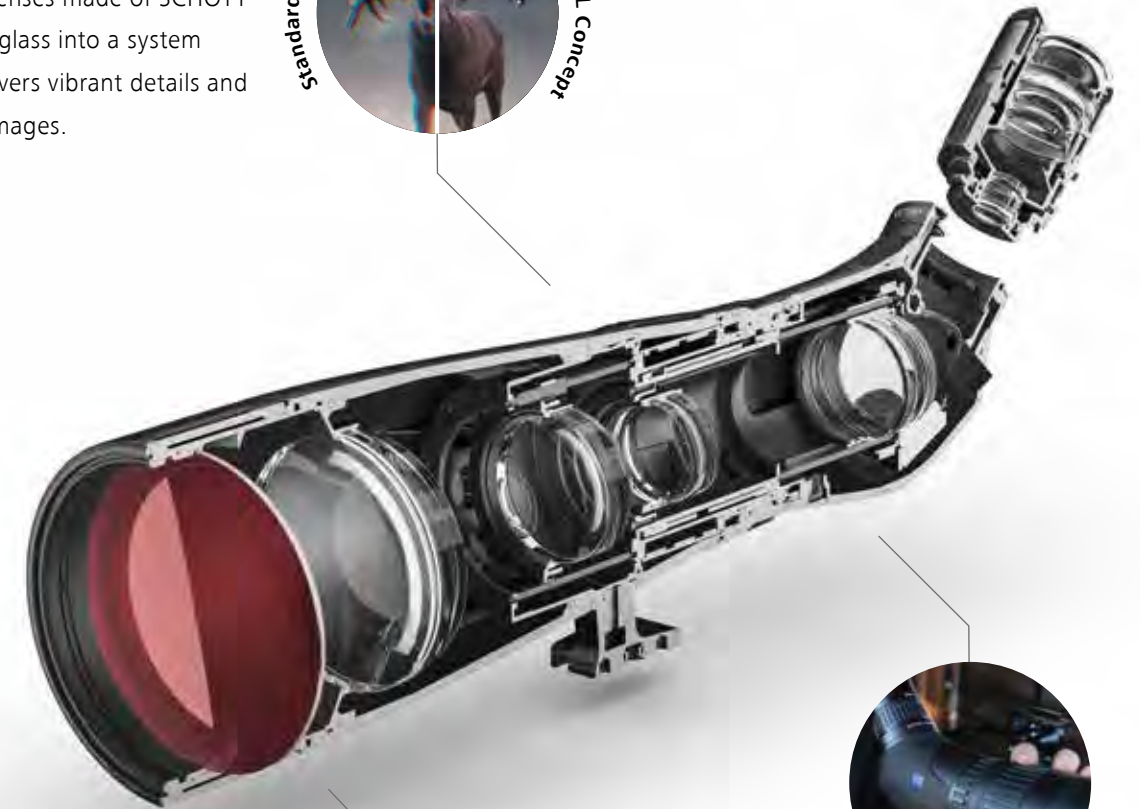
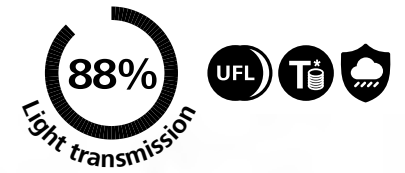
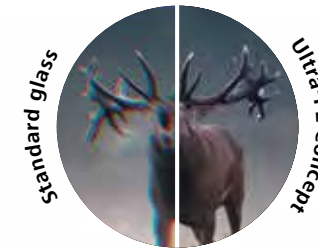

High-contrast and vibrant

T* multicoating for vibrant and high-contrast images.

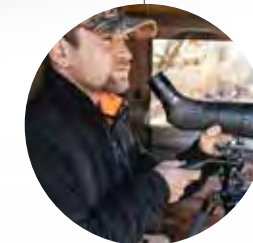

Unparalleled large zoom range

From maximum field of view at 23x magnification to maximum zoom at 70x magnification in seconds.

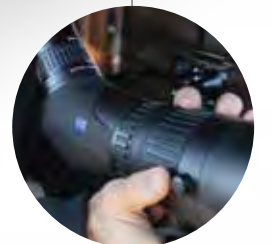



Harpia 95

The exceptional lens system features a 3× wide-angle zoom, up to 70× magnification, and a 95 millimeter lens diameter. Particularly noteworthy are the extremely wide fields of view, fast focusing, and precise focusing even at high magnifications.

Harpia 85

This spotting scope offers the same advantages as the Harpia 95 – with an 85 mm diameter lens. Thanks to FL glass and other special types of glass, the Harpia 85 provides an absolutely sharp and true-color view, even at maximum magnification.



TECHNICAL SPECIFICATIONS.

Victory spotting scopes	Harpia	
	85	95
Model	85	95
Light transmission	88 %	88 %
Focal length	162–486 mm	174–523 mm
Filter thread on lens	M86×1	M95×1
Lens diameter	85 mm	95 mm
Minimum object distance	3.5 m	4.5 m
Length×width×height	121×103×384 mm	124×109×408 mm
Weight without eyepiece	1,934 g	2,078 g
Waterproof	400 mbar	
Nitrogen filling	Yes	
Order no.	52 80 47	52 80 57

	Eyepiece	
	22–65×	23–70×
Magnification	22–65×	23–70×
Focal length	7.48 mm	
Field of view (1,000 m)	63.2–21 m	58.8–19.5 m
Zoom factor	3×	
Exit pupil diameter	2.50–1.31 mm	2.50–1.34 mm
Diameter	53 mm	
Length	71 mm	
Weight	220 g	
Order no.	52 80 70	

Includes eyepiece and lens cap. All feature ZEISS T* multicoating.

Subject to changes in design and scope of delivery as a result of ongoing technical development. More information can be found online at www.zeiss.com/consumer-products

Harpia adapters	Order no.
M49 photo adapter	52 83 57-9901
M52 photo adapter	52 83 57-9902
M58 photo adapter	52 83 57-9903

ZEISS IN THE FIELD



Care tips from ZEISS

The LotuTec® coating is both durable and abrasion-resistant, and its special surface creates a beading effect that makes cleaning the lens easier. We recommend using a ZEISS lens cleaning cloth to clean the lens surface. Do not wipe off coarse particles on the lenses, such as sand. Instead, wash them off or remove them with a lens brush.

ACCESSORIES



Professional Tripod

The ZEISS Professional tripod meets the highest standards in terms of compatibility and load-bearing capacity and offers particularly smooth panning. It is particularly suitable for our Victory products and for digiscoping.



Long Balance Plate

Our Long Balance Plate is the ideal solution to perfectly balance your spotting scope, especially when digiscoping (only for available for the Professional tripod).



Carrying Case for Victory Harpia

The pouch provides reliable protection against moisture and the elements, is comfortable to carry, and makes it possible to quickly use the spotting scope. The caps for the eyepiece and lens can be secured to the bag so you don't lose them.



ZEISS Photo Adapter

Whether for photography or videography, the photo adapter (M49, M52, M58) allows you to connect a digital camera directly to the Victory Harpia, turning the spotting scope into a powerful telephoto lens.



ON THE ROAD WITH EXPLORERS. CONQUEST GAVIA

Thanks to its impressive precision, low weight, and rugged construction, the ZEISS Conquest Gavia is an indispensable companion during expeditions off the beaten path.

The spotting scope with 85 mm objective lens diameter is particularly compact and lightweight. This makes it an ideal tool for both close-up and long-distance observation, especially in hard-to-reach areas. The spotting scope's minimum object distance is truly unique in this class, making it easy to view even the smallest objects.

The high-resolution lens system and fast, precise focus turn brief moments of observation into unforgettable views. Whether individual animals or an entire pack, with the Conquest Gavia 85's 60x magnification, hunters and nature watchers are sure to enjoy the details of nature in any situation.

LotuTec®



Even in wet weather, there are impressive things to see during the hunt. ZEISS developed LotuTec® precisely for this purpose. This is a coating on the lenses that provides unobstructed visibility in all weather conditions.

PRODUCT PROFILE

A COMPACT, LIGHTWEIGHT MODEL.



Perfect ergonomics

The spotting scope features a large focusing ring for precise operation and simple focusing.

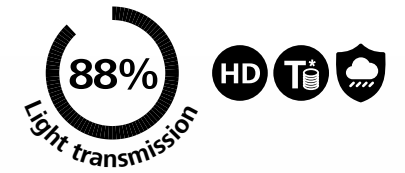

Light and compact

Its compact size and light weight make the Conquest Gavia an excellent travel spotting scope.



Minimal MOD

The spotting scope's minimum object distance of only 3.3 meters is truly unique in this class, making it easy to view even the smallest objects.

Vibrant and rich in detail

High-precision roof prisms and high-definition glass produce high-resolution images and fine sharpness. The T* multicoining delivers vibrant, high-contrast images.





Gavia 85

The spotting scope with 85 mm lens diameter is particularly compact and lightweight. This makes it an ideal tool for both close-up and long-distance observation, especially in hard-to-reach areas. The spotting scope's minimum object distance is truly unique in this class, making it easy to view even the smallest objects.



ZEISS IN THE FIELD

Care tips from ZEISS

The LotuTec® coating is both durable and abrasion-resistant, and its special surface creates a beading effect that makes cleaning the lens easier. We recommend using a ZEISS lens cleaning cloth to clean the lens surface. Do not wipe off coarse particles on the lenses, such as sand. Instead, wash them off or remove them with a lens brush.

TECHNICAL SPECIFICATIONS.

Model	Gavia 85
Light transmission	88%
Magnification	30–60×
Lens diameter	85 mm
Exit pupil diameter	2.8–1.4 mm
Focal length	494 mm
Field of view (1,000 m)	33–23 m
MOD	3.3 m
Lens type	HD
LotuTec® / Nitrogen filling	Yes / Yes
Waterproof	400 mbar
Lens thread	M86×1
Length	396 mm
Weight (incl. eyepiece)	Approx. 1,700 g
Order no. (incl. 30–60× 85 eyepiece)	52 80 48-0000-000

Includes eyepiece and lens cap.

Gavia adapters	Order no.
Astro Adapter	52 83 45
M49 photo adapter	52 83 48-9901
M52 photo adapter	52 83 48-9902
M58 photo adapter	52 83 48-9903

Subject to changes in design and scope of delivery as a result of ongoing technical development. More information can be found online at www.zeiss.com/consumer-products



ACCESSORIES



Carrying Case for Conquest Gavia

Specially designed for the Conquest Gavia, the pouch protects the spotting scope from external influences such as moisture and dirt. In addition, optimized carrying comfort, being able to quickly use the spotting scope, and the ability to secure the eyepiece and lens cap make the bag an indispensable piece of equipment.



Universal Tripod Plate

The universal tripod plate makes the Conquest Gavia compatible with a wide variety of tripods. Our Long Balance Plate is the ideal solution to perfectly balance your spotting scope, especially when digiscoping (only for available for the Professional tripod).



THE IDEAL HUNTING COMPANION.

DIALYT

Hunting in the mountains or in wide, flat country and heavy gear simply don't mix. As a result, when developing the Dialyt, we focused on compact dimensions, low weight, as well as reliability and durability.

Intuitive operation and the rugged rubber armoring in the classic Dialyt design round out the spotting scope's numerous impressive features. All in all, this is the perfect spotting scope for reliable target identification at long distances.



Dialyt

The lightweight, compact "hunting spotting scope" is specially designed for fast and precise target identification at long distances. Reliable functionality, the waterproof, anti-fog design, and ease of use make it the ideal hunting companion.

	Dialyt Spotting Scope
Model	18-45x65
Magnification	18-45x
Lens diameter	65 mm
Exit pupil diameter	3.6 mm / 1.4 mm
Field of view (1,000m)	40 m - 23 m
MOD	10 m
Lens type	Achromatic
Nitrogen filling	Yes
Watertightness	400 mbar
Length x width x height	395 x 78 x 76 mm
Weight	Approx. 1,195 g
Order no.	52 80 07

Includes eyepiece and lens cap. All feature ZEISS T* multicoating.

Subject to changes in design and scope of delivery as a result of ongoing technical development. More information can be found online at www.zeiss.com/consumer-products

PRODUCT PROFILE

PRECISION IN HARSH ENVIRONMENTS.



High-performance

The spotting scope impresses with detailed views and allows hunters to accurately identify targets at long distances thanks to its 45x optical magnification.

Lightweight

The compact monoblock design makes the Dialyt waterproof and the ideal companion for stalking and hunting from a raised hide.



124
125

ACCESSORIES

Tripod Mount

The Dialyt 18-45x65 can be positioned using a backpack or tree and also features a field-proven tripod mount. For long observations or in the absence of natural supports, we recommend setting up the spotting scope with a ZEISS carbon tripod. A lightweight monopod is another alternative.



Flexible

Bright, detailed views into the twilight hours for an excellent overview in all weather conditions or at any distance.

OUTSTANDING VISIBILITY, EVEN UNDER A NEW MOON VICTORY NV.

Rugged design

The rubber-armored housing is waterproof and nitrogen-filled, effectively protecting the optics and mechanical components from environmental influences.

A perfect combination

The 62 mm lens gathers available light and focuses it onto the high-sensitivity photocathode.



Superior image amplifier tube

The amplifier tube with approximately 20,000 times light amplification contains a microchannel plate (MCP) to generate detailed, high-contrast images at night.



5.6×62 NV

The latest image intensifier tubes use the minimal amount of light available to make the observed game appear 20,000 times brighter. In the absence of light, the built-in IR LED can be activated at the touch of a button. The LED emits infrared light that makes observations with the NV device possible up to a distance of approx. 50 meters. Connecting an additional flashlight with IR filter can extend the illumination range up to several hundred meters.

OTHER OPTICAL DEVICES FROM ZEISS. AN OVERVIEW.



ZEISS Mono

The 3×12 is a powerful miniature telescope with 3× magnification. It transforms Victory* and Conquest binoculars with a 30 mm lens or larger into a powerful spotting scope in the blink of an eye. Simply attach it to the eyepiece with an adapter ring. Can be used separately as a magnifying glass at close range.

* Cannot be used with Victory SF models.



ZEISS Mono

For detailed observation at sporting events, the theater, or outdoors over long distances – the Mono models with ZEISS T* multicoating stand out for their bright, clear view and, depending on the model, can also be used as magnifying glasses.



AntiFOG Kit

ZEISS AntiFOG spray is applied gently and quickly to the lens of your binoculars, riflescopes, or spotting scopes. The result; the lens remains fog free for up to 72 hours – without interfering with its optical quality. In order to ensure that ZEISS AntiFOG achieves the best results, the lens should first be cleaned with the included ZEISS lens cleaning wipe. This makes it easy to maintain a crystal clear view, even in extremely humid conditions.



20×60 S

Exceptional binoculars designed for the longest distances and even used on the International Space Station (ISS). The bright Porro prism system produces extremely sharp images with outstanding detail resolution, even at 20× magnification. The technologically unrivaled mechanical image stabilization that allows you to simply “turn off” the unavoidable shaking that occurs during hand-held observation is what makes the 20×60 T* S perfect.

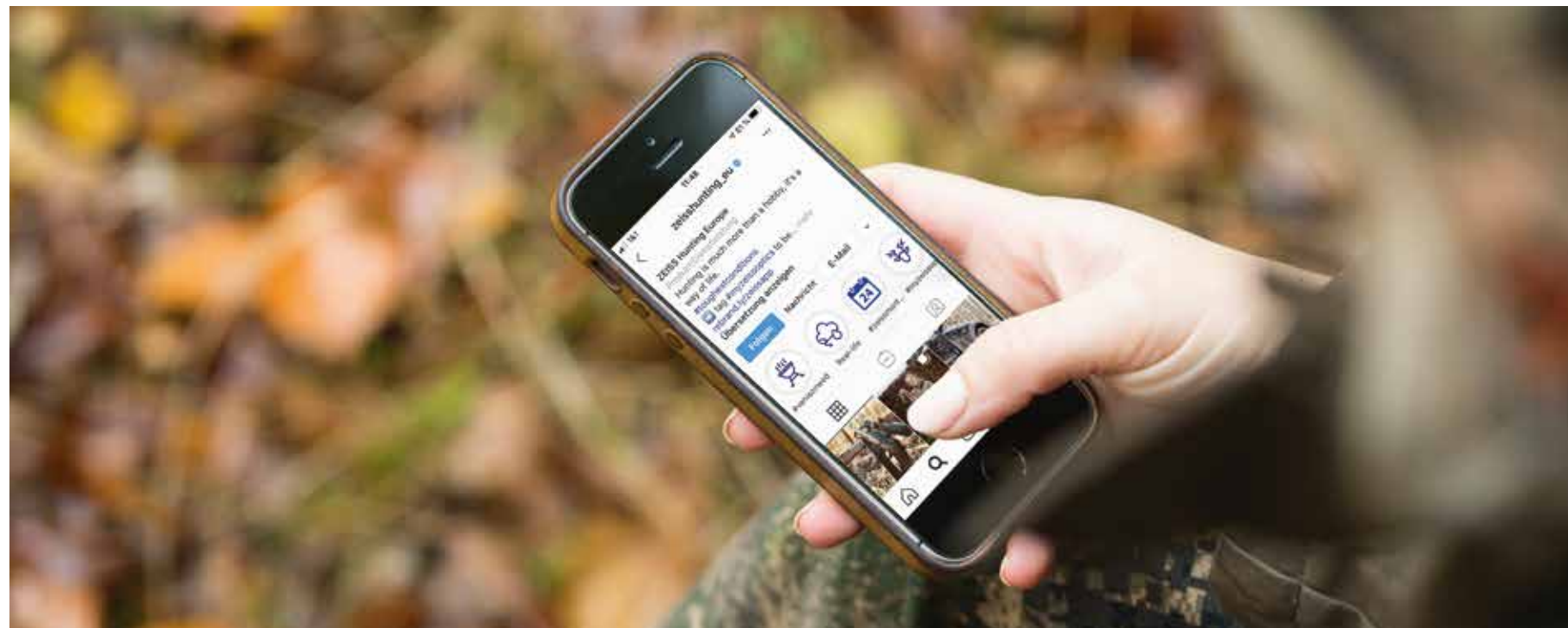
EXPERIENCE ZEISS **ONLINE.**

Become a part of the ZEISS Hunting community! Our social media profiles feature exciting hunting-related content – from inspiring European hunting grounds to showcasing our products in the wild and regional game recipes.





Check out our Instagram account and Facebook page for regular visual updates from the field. Here you can view our products in action and receive exclusive information on new features. To have your own snapshot featured on the ZEISS Instagram page, simply add the hashtag #myzeissoptics below your photos.

The ZEISS Hunting blog offers many insights into the experiences of hunters from all over the world. Get important tips and tricks on different types of hunting and learn background information on technological developments in the field of hunting optics.

Read exciting stories, some of them with impressive images, insightful field reports, and product endurance tests. In addition, you will find, for example, inspiration for delicious game recipes – always from hunters for hunters. Using the practical filter option, you can select the articles that interest you the most.

If you want to take a closer look at our products, subscribe to our ZEISS Hunting YouTube channel. Here you will find individual video playlists organized around specific topics, for example about the ZEISS Hunting App, stalking, or night hunting. External product tests and detailed reviews of our optical devices are also available here.

FOLLOW US ON THE WEB:

-  facebook.com/ZEISSHunting
 -  zeiss.com/hunting/blog
 -  youtube.com/user/zeissportoptics
 -  [ZEISShunting_EU](https://instagram.com/ZEISShunting_EU)
-

DESIGNED FOR PRECISION.

ZEISS ACCESSORIES.

Bullet Drop Compensator (ASV) Order no.

LongRange (ASV LR)

for ZEISS V8 1.8–14×50, 2.8–20×56



for elevation (new orders)

-040

for windage (new orders)

-050

Advanced LongRange (ASV-ALR)

for ZEISS V8 4.8–35×60



for elevation (new orders)

-040

for windage (new orders)

-050

ASV+

for Victory HT



for elevation (new orders)

-010

for elevation and windage (new orders)

-020

BT V6

for Conquest V6



Ballistic turret (BT)

-060

External windage (EW)

-070

Throw Lever Order no.

for ZEISS V8 and Conquest V6



2224-899

for Conquest V4

2248-168

Flip Cover Order no.

for ZEISS V8, Victory HT



Ø 30 mm

2152-898

Ø 50 mm

2105-737

Ø 56 mm

2105-798

Ø 60 mm

2173-926

Neoprene Cover Order no.

Size chart for suitable models at
www.zeiss.com/hunting/accessoires



Size S for V8 1.1–8×24, V6 1.1–6×24,

V4 1–4×24 models

2231-631

Size M for HT 2.5–10×50, V6 2–12×50,

V6 3–18×50, V4 4–16×44 models

2231-632

Size L for V8 1.8–14×50, V8 2.8–20×56, HT 3–12×56,

V6 2.5–15×56, V6 5–30×50, V4 3–12×56, V4 6–24×50 models

2231-633

Size XL for V8 4.8–35×60 model

2231-634

Sunshades Order no.

for ZEISS V8, Victory HT, Conquest V6 and Conquest V4



Ø 44 mm

529860-0001-000

Ø 50 mm

529860-0002-000

Ø 56 mm

529860-0003-000

DTC 3 adapter Order no.

DTC-R M52 (one size)

52 83 30



DTC-A 48

for riflescopes with a lens diameter of 42 mm

52 83 32

DTC-A 56

for riflescopes with a lens diameter of 50 mm

52 83 33

DTC-A 62

for riflescopes with a lens diameter of 56 mm

52 83 34

INCREASES PERFORMANCE. ZEISS ACCESSORIES.

Tripod Adapter		Order no.
Binofix universal tripod mount for all binocular models		52 83 87
¼" tripod adapter for Conquest HD (included with the HD 15×56)		52 83 88
Magnification Attachment		Order no.
Mono 3×12 incl. carrying strap and leather pouch; triples normal binocular magnification		52 20 12
Adapter for Magnification Attachment		Order no.
for Victory FL/RF/HT (not SF) and Conquest HD 32 and 42		52 83 77
for Conquest HD 56 & Victory RF		52 83 79
Accessories for Victory NV 5.6×62		Order no.
SLR camera adapter		52 30 06-9007
1" flashlight mount		52 30 06-9006
Mini Maglite adapter		52 30 06-9008



Cordura Pouches		Order no.
for DTI 3/35 and DTI 3/25		2374-931
for Victory SF 32/SFL 40 (pictured)		2238-133
for Victory HT 54		2074-447
for Conquest HD 32/Terra ED 32 (pictured)		52 90 35
for Conquest HD 42/Terra ED 42 (pictured)		1976-008
for Conquest HD 56		1379-711

Pouches		Order no.
Victory SF 42/RF 42 (pictured)		2060-069
Victory RF 54		2214-573
Victory Pocket		2165-340
Terra ED Pocket		2197-806
Terra ED 32 (pictured)		2196-165
Terra ED 42 (pictured)		2196-167
Leather pouch for 20×60 S		52 90 83

Carrying strap		Order no.
Air Cell Comfort straps		52 91 13
Comfort Cross straps for binoculars		52 91 15

TECHNICAL SPECIFICATIONS.

Victory Model	Monos					
	3 × 12	4 × 12	6 × 18	8 × 20	10 × 25	MiniQuick® 5 × 10
Magnification	3 ×	4 ×	6 ×	8 ×	10 ×	5 ×
Lens diameter	12 mm		18 mm	20 mm	25 mm	10 mm
Exit pupil diameter	4 mm	3 mm		2.5 mm		2 mm
Twilight factor	6	6.9	10.4	12.6	15.8	7
Field of view (1,000 m)	220 m	180 m	120 m	110 m	88 m	100 m
Angular field of view	38°	41°		51°		29°
Close focusing distance	0.2 m	0.25 m	0.3 m	3 m	4.5 m	4 m
Diopter adjustment range	± 4 D					
Exit pupil distance	12 mm	15 mm				16.5 mm
Lens type	Achromatic					
Prism system	Schmidt-Pechan					–
Waterproof	Splash-proof					
Operating temperature	-20 / +40 °C					
Height × width	58 mm	70 mm	94 mm	101 mm	119 mm	113 mm
Weight	54 g	45 g	58 g	67 g	77 g	23 g
Order no.	52 20 12	52 20 50	52 20 51	52 20 52	52 20 53	52 20 10

All feature ZEISS T* multicoating.
Subject to changes in design and scope of delivery as a result of ongoing technical development.

Model	Binoculars with image stabilization
	20 × 60 S
Magnification	20 ×
Lens diameter	60 mm
Exit pupil diameter	3 mm
Twilight factor	34.6
Field of view (1,000 m)	52 m
Angular field of view, real	60° wide angle
MOD	14 m
Diopter adjustment range	± 7 D
Exit pupil distance	13 mm
Interpupillary distance	57 – 73 mm
Lens type	Achromatic
Prism system	Porro
Waterproof	Splash-proof
Operating temperature	-20 / +40 °C
Height × width	275 × 161 mm
Weight	1,660 g
Order no.	52 60 00

Includes neoprene carrying strap, eyepiece cap, and aluminum case.
Subject to changes in design and scope of delivery as a result of ongoing technical development.

Model	Night Vision
	5.6 × 62 NV
Magnification	5.6 ×
Lens diameter	62 mm
Field of view (1,000 m)	142 m
MOD	5 m
Diopter adjustment range	+ / - 4 D
Exit pupil distance	20 mm
Coating	LotuTec®
Nitrogen filling	Yes
Length × width × height	233 × 100 × 80 mm
Weight	Approx. 1,000 g
Reticle: line spacing	0.5 m / 100 m
Measuring range/range	500 m
Order no.	52 30 07-9901

Package includes eyepiece and lens caps, carrying strap, cordura pouch, and two AA batteries.
Subject to changes in design and scope of delivery as a result of ongoing technical development.



TECHNICAL SPECIFICATIONS.

Model	Tripod	Long Balance Plate
	Professional	
Material	Carbon	for the professional model
Length when closed	Approx. 700 mm	
Length when open	Approx. 1,820 mm	
Weight	Approx. 2,460 g	
Order no.	21 69-972	21 69-974

Model	Carrying Case for
Conquest Gavia 85	2169-979
Victory Harpia 85	2169-977
Victory Harpia 95	2169-976

Model	Astro Adapter for
1¼" astronomical telescopes	52 83 85
2" astronomical telescopes	52 83 86
Astro adapter for DiaScope	52 83 82



Become a part of the **ZEISS Hunting community**.

Follow us on the web:



facebook.com/ZEISSHunting



zeiss.com/hunting/blog



youtube.com/user/zeissportsoptics



ZEISShunting_EU

Customer Care

Carl Zeiss Sports Optics GmbH – Customer Care

Gloelstraße 3 – 5, 35576 Wetzlar, Germany

Phone +49-800-934-7733 | Fax +49-644-148-369

consumerproducts@zeiss.com

Carl Zeiss AG

Consumer Products Business Group

Carl-Zeiss-Straße 22

73447 Oberkochen

Germany

www.zeiss.com/hunting

