

# MINOX

Great Price. Great Performance.

**MINOX**

Great Price. Great Performance.

"I want a flexible optic that simply does a good job. Status symbols can be bought by others."

# My MINOX.

For 85 years, the MINOX brand has stood for quality and precision. We have a passion for high-quality optics and show this in every detail of our products. Transparency and honesty are the cornerstones of our brand philosophy.

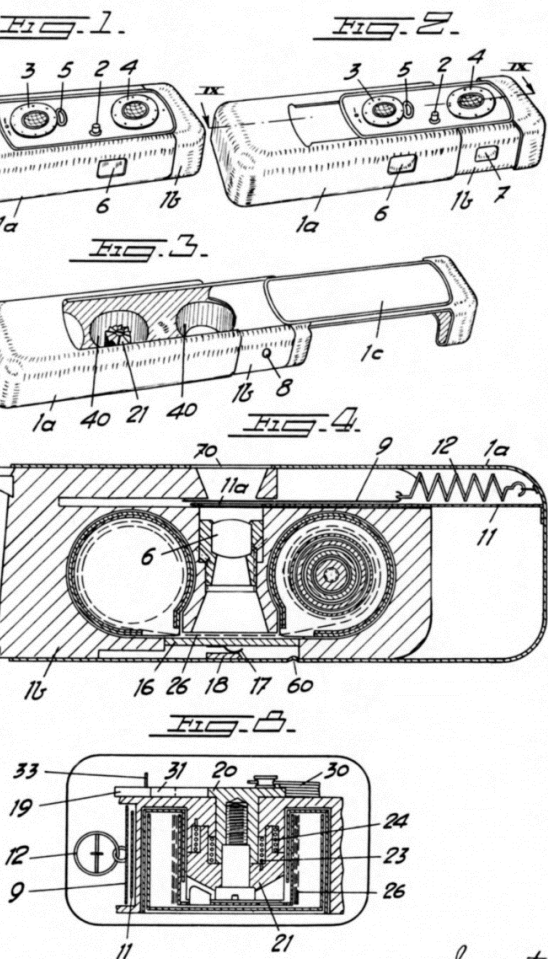

*Inventor  
Walter Zapp.  
A. Sommers & Young  
Attys*

# The Zapp story.

Since 1936, when the first prototypes of the legendary spy camera Riga were developed by founder Walter Zapp, we as a traditional company have lived by the same values - reliability, compactness, precision.

  
**MADE  
IN GERMANY**

# My Optic.

We make no compromises in the development of our products. We offer outstanding craftsmanship in equipment at a fair price. The concentrated know-how of our factory in the optical city of Wetzlar is noticeable in every detail of our optical equipment.

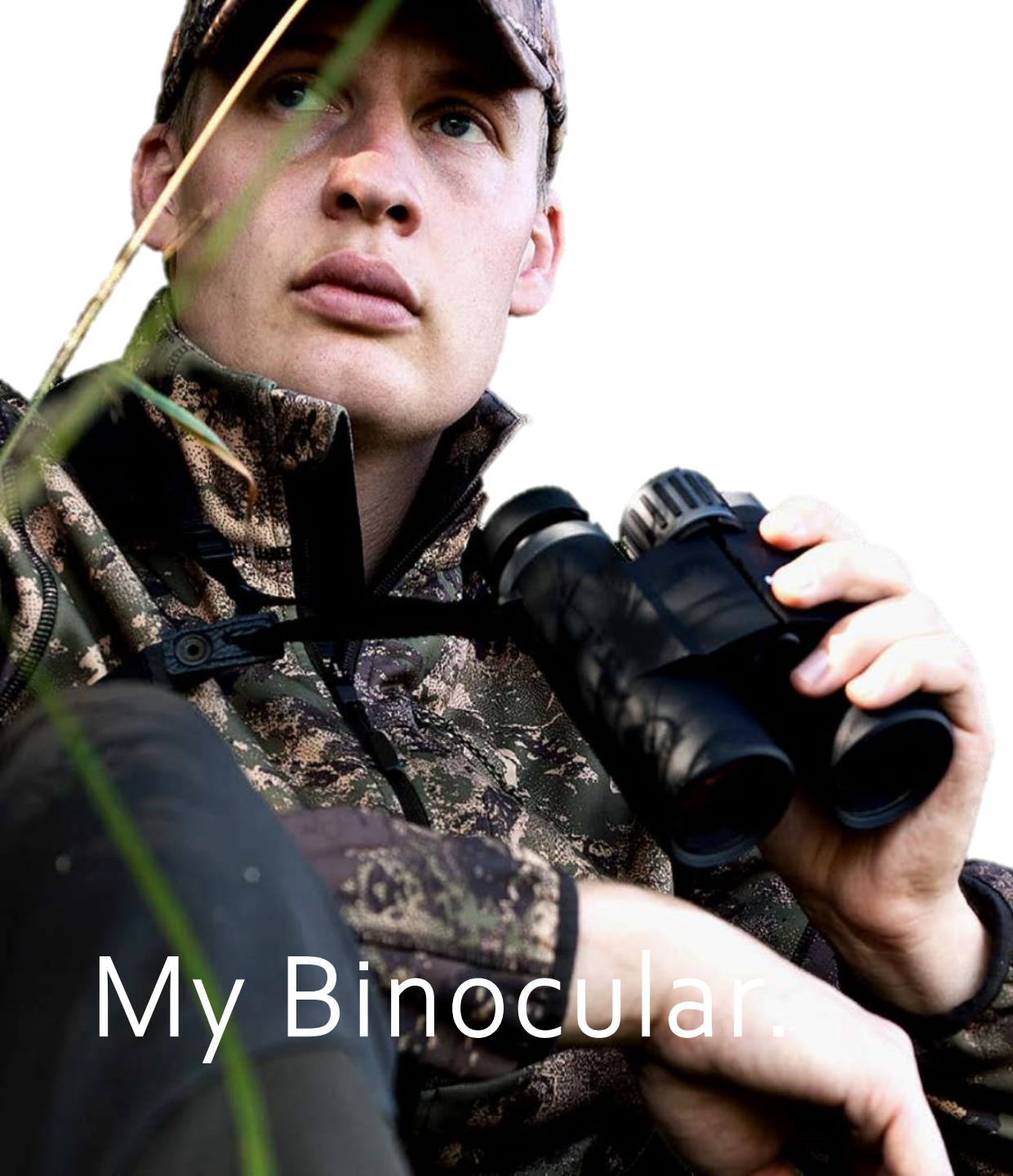

My Binocular.

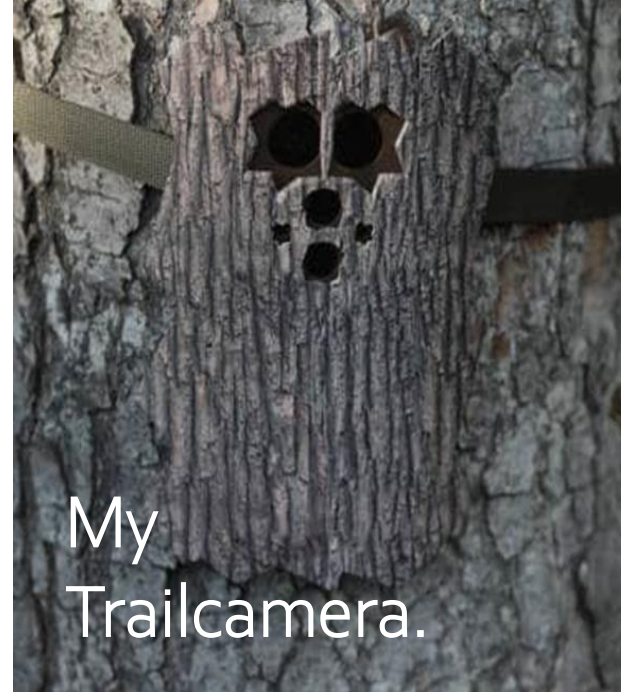

My Trailcamera.



My Riflescope.



My Spotting Scope.

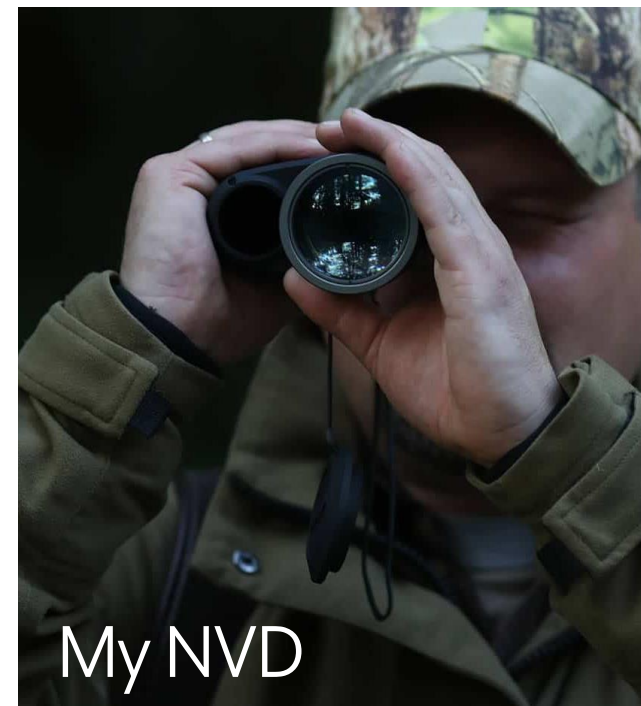

My NVD

**MINOX**

Great Price. Great Performance.



# My Riflescope. My MINOX.

For a safe shot right down to the last light. For uncompromising precision and repeatability. Each of our riflescope models is designed to be the reliable tool of the highest demands.



PRO



Allrounder



Long-Range



Red Dot



# ALLROUNDER

Flexible in use and uniquely priced.

Available as : 1-5x24 | 2-10x50 | 3-15x56

All lenses also available as rail version Z-inner rail (Z=Zeiss)



**MADE  
IN GERMANY**



**MINOX**  
Great Price. Great Performance.

Products	USP	Technical features
All	A brilliant picture and excellent contrast in all lighting conditions - until deep into the dawn	Maximum transmission of up to 94 % according to DIN ISO 14490-5
All	Increased battery life	Time and position controlled automatic switch-off of the light point.
All	Reduced minimalist appearance and good overview	Extra low adjustment towers and minimalist housing design
All	The illuminated reticle does not outshine in dawn and is clearly visible in backlit conditions	Smoothly adjustable illuminated reticle #4 with large adjustment range
All	Battery container for quick and easy change in case of emergency	Battery container with spare battery
All	The Allrounder can be quickly and easily converted for spot shots at a distance, thanks to MINOX's own quick reticle adjustment system	Optionally available, upgradeable quick reticle adjustment (FRA turrets)
All	Fast and easy focusing thanks to MINOX's own FTA optics design	FTA (Fast Target Acquisition) Target fast acquisition through a special optics design and the magnified eyepiece.
1-5x24	Sight with both eyes open	1x initial magnification
2-10x50	Universally usable from driven hunt to raised hide	Allround magnification range from 2x to 10x
3-15x56	Especially suitable for dawn and dusk hunting	Large lens diameter collects a lot of light



# MINOX

Great Price. Great Performance.

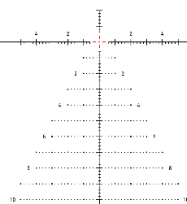

**MADE  
IN GERMANY**



## LONG-RANGE

Available as : 5-25x56 LR incl. Long-Range Reticle

USP	Technical features
Extremely robust and durable	34 mm center tube with high body thickness
Highest shot strength and repeatability	Precise mechanics and robust construction
Excellent light transmission, contrast and color accuracy	M* Multiple coating
All settings can be made even when wearing gloves and in poor lighting conditions	User-friendly and practical controls
No magnification of the reticle when zooming and intuitive quick distance estimation	Reticle in the 1st focal plane
Practice-oriented reticle, for hunting and sport shooting	MINOX LR Reticle. In-house development by MINOX



MADE  
IN GERMANY



PRO

Available as : ZP5 3-15x50 | ZP5 5-25x56

**MINOX**  
Great Price. Great Performance.

Products	USP	Technical features
All	Extremely robust and resistant	34 mm center tube with high body thickness
All	Highest shot strength and repeatability	Precise mechanics and robust construction
All	Excellent light transmission, contrast and color accuracy	M* Multiple coating
All	All settings can be made even when wearing gloves and in poor lighting conditions	User-friendly and practical controls
All	No magnification of the reticle when zooming and intuitive quick distance estimation	Reticle in the 1st focal plane
ZP5 3-15x50	Practice-oriented reticle available for every use case	MR2, MR5
ZP5 5-25x56	Practice-oriented reticle available for every use case	MR2, MR4, MR5, THLR Hybrid

# PRODUCT SERIES COMPARISON

Feature	PRO	Allrounder	Long-Range
34 mm center tube	•		•
30 mm center tube		•	
High-tech special glass	•	•	•
M* Multiple coating	•	•	•
Reticle in the 1st focal plane	•		•
Reticle in the 2nd focal plane		•	
Parallax adjustment	•	• <sup>*3-39x56</sup>	•
Illuminated reticle / Infinitely adjustable	•	•	•
Auto. switch off light point	•	•	•
Waterproof according to IPX7	•	•	•
Nitrogen gas filling	•	•	•
Extra low adjustment towers		•	
Improved insight behavior FTA		•	
Glass Fiber Reticle Glass Fiber Point		•	
Position sensor for reticle cutoff		•	•
MINOX Comfort Service 	•	•	•
Compatible with night vision and thermal imaging technology	•	•	•



# Areas Of Application

Feature	Driven hunt	Stalk / Universal	Hide / Dawn	Long-Range / Sport Shooting	Authority
Allrounder 1-5x24 (S)	•				
Allrounder 2-10x50 (S)	•	•			
Allrounder 3-15x56 (S)		•	•		•
5-25x56 LR			•	•	
ZP5 3-15x50		•		•	•
ZP5 5-25x56			•	•	•
RV1 Red Dot	•	•		•	•





RV1

Movement in hunting and budget

USP	Feature
Designed for fast target acquisition	Finest 2 MOA illuminated dot
Illuminated dot does not outshine in the dark and is clearly visible when backlighting	Illuminated dot in 11 brightness levels (of which 3 levels night vision optimized)
Made for movement	Extremely compact, lightweight and robust design
Battery replacement becomes a rarity	Up to 8.5 years battery life (50,000 h)
Variable mounting	Includes removable Weaver / Picatinny mount When removing the adapter, can also be used for AIMPOINT mounts

**MINOX**

Great Price. Great Performance.



# My binoculars. My MINOX.

for outdoor adventures, wildlife and nature observation or for theater. Our three binocular lines are tailored to the most diverse needs. Maximum edge sharpness, color brilliance and an ergonomic design are just a few of the talents of our binoculars.



X-range



RAPID



X-lite



X-active



X-HD



## X-Range

The binocular with laser range finder

Available as:

10X42



USP	Technical features
Key functions programmable, therefore optimal handling whether with left or right hand side	Freely selectable key assignment
Accurate measurement even in poor weather conditions	
light & yet robust housing makes it the ideal companion in a backpack or jacket pocket	Enormously robust and compact magnesium housing
Perfect for targeting animals	Brilliant HD optics through multi-coated ED lenses
Modern OLED display - Adaptable to all lighting conditions	5 brightness levels with display options "Distance & Angle, Distance & Horizontal Distance"
Accurate measurement up to 2800 meters away	

**MINOX**

Great Price. Great Performance.



## X-RAPID

The fastest MINOX binoculars

Available as:

7.5x44



USP	Technical features
Focusing from approx. 20m to infinity not required	Pre-focusing supports your eyes' own focus adjustment during object detection
New rubber wiper lips prevent dust, dirt or moisture from entering the eyepiece interior	No moving parts inside the optics, sealing principle from hydraulic technology Hydraulic technology removes dust from the eyepiece area when the metal eyepiece sleeves are pushed in and out
Comfort bridge for safe one-hand operation, e.g. when stalking	
Watch for long periods without fatigue	Lightweight polycarbonate case / well balanced
No comparable hunting glass on the market M* Coating	



**MINOX**

Great Price. Great Performance.



Products	USP	Technical features
All	Convincingly bright image in poor visibility conditions	ED lenses for high contrast and very good detail recognition
Alle	Even in difficult lighting conditions such as backlighting and low sun, show neutral imaging performance.	Feature the new M* Plus coating
Alle	Provides maximum light output for image brightness during night hunting	with an extremely high light transmission value of more than 92%.
Alle	Lotus flower effect	MINOTECH coating
Alle	Ideal fitting for eyeglass wearers (also with varifocal lenses)	Unscrewable eyecups
Alle	Use on target pole or monopod with tripod adapter	Tripod thread
8x44/10x44 / 8x56	Ergonomic handling...	...through open bridge (comfort bridge)

## X-HD Series

Binoculars for highest demands

Available as:

8x44, 10x44, 8x56



# MINOX

Great Price. Great Performance.



## X-active

The allrounder for every application

Available as:

8x25, 10x25, 8x33, 10x33,

8x44, 10x44, 8x56

Products	USP	Technical features
All	Its lightweight but rugged housing makes it the ideal companion in a backpack or jacket pocket.	Polycarbonate housing (carbon fiber reinforced)
All	Ideal fit for eyeglass wearers	Unscrewable eyecups
All	Even in difficult lighting conditions such as backlighting and low sun, show neutral, imaging performance.	Dispose of the new M* coating
All	No fogging from the inside	Nitrogen gas filling
All	The high detail reproduction and the large fields of view deepen the experience of nature and open up new visual impressions.	Neutral color reproduction and high contrast
All	Ergonomic handling	The ergonomic design with comfort bridge and perfectly balanced housing
All	Pressure waterproof up to 5m	
8x33	Large field of view up to 140m	
8x44	Large field of view up to 136m	





## X-lite



The outdoor lightweight.

Available as:

8x26, 10x26, 8x34, 10x34,  
8x42, 10x42, 8x56

Products	USP	Technical features
All	Ideal fit for eyeglass wearers	Unscrewable eyecups
All	Ergonomic handling	The ergonomic design with open bridge
All	Waterproof up to 1m	
All	Even in difficult lighting conditions such as backlighting and low sun, show neutral, imaging performance.	Have the new M* multilayer coating
8x26/10x26	Ideal for use during the day	
8x34/10x34	For daytime observation and use even in harsh lighting conditions	
8x42, 10x42	Universal glass until dawn, hiking, stalking, bird watching	
8x56	As an entry level glass for deep dawn and night hunting	

# PRODUCT SERIES COMPARISON

Serie / Modell	X-range	RAPID	X-HD	X-active	X-lite
Phase corrected prisms	•	•	•	•	•
Unscrewable eyecups	•	•	•	•	•
Nitrogen gas filling	•	•	•	•	•
Pressure waterproof	•	•	•	•	•
M* Multilayer coating	•	•	•	•	•
Comfort bridge		•	•	•	•
MINOX Comfort Service up to 10 years warranty 	•	•	•	•	
Integrated laser range finder	•				
High-tech special glass	•		•		
ED Optics	•		•		
Single eyepiece adjustment		•			
Lightweight construction			•		
Cleaning seals		•			
Made in Germany 			•		
Areas of application	Anyone who wants to measure. Hunting to leisure	High demand for robustness Fastes binocular	Ambitious user, daily user. In everyday work  High standard	Highest standards. Daily in use and everyday work	entry level & casual user



# AREAS OF APPLICATION

Feature	Outdoor / Hiking	Stalking / Day Hunting	Nature Observation / Birding	Hunting night / Stalking night
X-Range 10x42	•	•	•	
Rapid 7,5x44	•	•	•	
X-HD 8x44 / 10x44		•	•	
X-HD 8x56			•	•
X-active 8x25 / 10x25	•			
X-active 8x33 / 10x33	•	•	•	
X-active 8x44 / 10x44		•	•	
X-active 8x56			•	•
X-lite 8x26 / 10x26	•			
X-lite 8x34 / 10x34		•	•	
X-lite 8x56			•	•



**MINOX**

Great Price. Great Performance.



# My spotting scope. My monocular. My MINOX

Get to the bottom of things, explore the secrets of nature down to the last detail. Fascination lies in the detail. Ideal for the demands of ornithology, the sport shooter or orientation in unknown terrain. Our portfolio of compact spotting scopes and monoculars offers you a brilliant image from near to far.



MD 80 ZR



MD 50 W



MS 8X25



MD 7X4.2 C



## MD 50 W

Pocket-sized optical performance

Equipped with a vario eyepiece for 16x to 30x magnifications.

USP	Technical features
High detail reproduction and contrast	Multi-layer coating ensures strong contrast and outstanding detail recognition
16 to 30x magnifications	Continuously adjustable Vario eyepiece with twist-out eyecup for adaptation for eyeglass wearers
Rotatable tripod base	90 degree rotating tripod clamp with click stops for concealed observation
Pressure waterproof up to 3m	
Observation glass for bird watching and shooting sports	
Variable magnifications for more flexibility and mobility	
Features an angled eyepiece for comfortable viewing	45 degree viewing and screw-on eyepiece protection cap
Compact and lightweight	

Mountain hunting, nature observation, bird watching, sport shooting ( on 50m stands)



## MD 80 ZR

Pocket-sized optical performance

Infinitely adjustable Vario eyepiece  
for 20x to 60x magnifications

USP	Technical features
more flexibility and mobility	innovative optics concept are 20% shorter than conventional spotting scopes
Precise determination of game and birds. In addition, as a precision scope with the built-in reticle, they are an ideal addition to the equipment of long-range shooters.	Built-in MR2-S precision reticle in the first image plane - for reliable distance estimation
The high detail reproduction and the large fields of view deepen the experience of nature and open up new visual impressions.	High contrast, neutral color reproduction
	Built-in retractable lens hood
Universal tripod thread 3/8 inch	
20 to 60x magnifications	
Can be combined with the ZP & LR scopes	



**MINOX**

Great Price. Great Performance.



## MS 8X25 Macroscopic

The powerful mini telescope

With 8x magnification & extremely short close-up focusing range of only 35 cm.

USP	Technical features
8x magnification	
Ideal for all outdoor activities, whether climbing, hiking, cycling. Whether in the stadium, open air concert, theater, city tour, excursions, etc..	Close range from 35 cm
Ideal for eyeglass wearers	Unscrewable eyecup
Extremely light	
Recognized medical-optical aid	
With tripod thread for walking stick or monopod	

**MINOX**

Great Price. Great Performance.



## MD 7X42 C

The compact navigator

USP	Technical features
7x magnification	
Precise analog compass	
The graticule is ideally suited for orientation in the terrain and for distance determination	Graticule for distance calculation
Large field of view of 114 meters	
Safe one-hand operation including loop	
Waterproof up to 1m water depth	
No fogging from the inside	Nitrogen gas filling
Large eyepiece lens	
Ideal fit for eyeglass wearers	Unscrewable eyecups

**MINOX**

Great Price. Great Performance.



# My trail camera. My MINOX.

Whether as a photo trap, at the nesting box or in the forest and fields. Starting with the flattest wildlife & observation camera up to the smart 4G broadcast camera with free app, our product portfolio covers a wide range of applications.



DTC 395



DTC 460



DTC 550 WIFI



DTC 1200



## DTC 1200 / 4G Camera

The lion king among the cameras

USP	Technical features
Always on the optimum mobile network in any area thanks to domestic roaming	4G broadcast standard
Automatic switch to the best network in each case	Switch to the stronger mobile network in the event of network fluctuations
User-friendly app to receive the sent photos	IOS, Android App
Unlimited images for 5.99 euros per month, can be cancelled monthly	Data storage in Germany, German data protection standard
	Image resolution up to max. 20 MP
	60 LEDs with 940 nm for a range of up to 20 m
GPS tracking	GPS function for exact camera location
Battery magazine for effortless battery change	12 x 1.5 AA batteries
Unlimited number of app users	



## DTC 550 WiFi

Reliable observer

USP	Technical features
Large 2.4" color monitor - for viewing images on site	
Short image release 0.4 seconds	
Invisible IR flash with 15 meters range	Timer function
Connection for external power supply	
Best image quality day and night	HD video resolution (1080p), up to 12 MP
Up to 9 continuous shots & videos up to 3 minutes long	SD/SDHC card with up to 32 GB
Convenient data transfer and system settings management. Copy pictures from camera to phone	WiFi connection and app within 10 meters



USP	Technical features
Thinnest camera on the market, housing only approx. 34 mm high	2.4" inch display One front panel with coarse tree bark texture included in delivery
Easy camera setup due to front camera display	
3 optional front panels for the perfect camouflage in nature	Data storage via SD/SDHC card with max. 32 GB
Bar magazines for quick and easy battery replacement	
Triggering time 0.7 sec.	Image resolution up to max. 12 MP
Photos and videos in HD	

## DTC 460

Changeable adaptation artist



## DTC 395

The Basic

USP	Technical features
Invisible IR flash with 15 meters range	
Best image quality day and night	Full HD video resolution, up to 12 MP
Large 2.4" color monitor - for viewing images on site	
Battery life of up to 6 months	8x 1.5V AA alkaline, lithium, NiMH batteries or 6V external power supply

# PRODUCT SERIES COMPARISON

Product	DTC 1200	DTC 550 WiFi	DTC 550	DTC 460	DTC 395
Category	4G transmission function and pre-installed SIM card	Game camera with data transmission via WiFi	Game camera	Game camera with removable front panel	Game camera
Control via app	•	•			
GPS tracking	•				
Motion sensor range	up to 20 m	up to 15 m	up to 15 m	up to 15 m	up to 15 m
Trigger time	0.6 sec.	0,4 sec.	0,4 sec.	0,7 sec.	0,7 sec.
Image resolution	up to max. 20 MP	up to max. 16 MP	up to max. 12 MP	up to max. 12 MP	up to max. 12 MP
External memory SD/SDHC card with up to 32 GB	•	•	•	•	•
Display	2.0" TFT color display	2,4" TFT color display	2,4" TFT color display	2,4" TFT color display	2,4" TFT color display
Powerful IR flash	15m range, No glow 940nm	20m range, Low Glow 850nm	15 m range, No Glow 940nm	15 m range, Low Glow 850nm	15 m range, No Glow 940nm
Continuous images per triggering	1-10 (adjustable)	1-9 (adjustable)	1-9 (adjustable)	1-3 (adjustable)	1-3 (adjustable)
Video resolution	Max. 1920x1080	Max. 1920x1080	Max. 1920x1080	Max. 1920x1080	Max. 1920x1080
Daytime color photos	•	•	•	•	•
Black and white shots at night	•	•	•	•	•
Control	Via app	App and 10-button control	App and 10-button control	App and 10-button control	App and 10-button control
Standby time	approx. 6 months	Up to 6 months	Up to 6 months	Up to 6 months	Up to 6 months
Microphone	Integrated	Integrated	Integrated	Integrated	Integrated
Connections	USB, 6V/2A DC	USB, 6V DC (min. 2000 mA)	USB, 6V DC (min. 2000 mA)	USB	USB, 6V DC (min. 2000 mA)



**MINOX**

Great Price. Great Performance.



# My night vision device. My MINOX.

From dusk until deep into the night, when not only the eyes but also high-performance binoculars reach their limits, our night vision devices offer the decisive advantage.



NVD650



## NVD 650

Observing, photographing, filming

USP	Technical features
Turns night into day with digital light amplification	Night vision device with built-in IR illuminator
6x magnification (optical), 5x digital (= max. 30x magnification)	
Range up to 350 m	Powerful IR emitter (850 nm wavelength)
Use also possible during daylight	
Mounting rail for additional spotlight	
Observing, photographing or filming with a resolution of up to 2590 x 1944 pixels	microSD/microSDHC card with up to 32 GB

# PRODUCT DATA

Product	NVD 650
Magnification	6 x (optical), up to 30 x (combined by digital zoom)
Functionality	Digital
Powerful IR emitter	Range up to 350 m
Operating temperature	-30° to +55°C
Energy supply	4 x 1.5 V AA batteries / alkaline, lithium or NiMH batteries
Video output	NTSC or PAL
External memory	microSD/microSDHC card with up to 32 GB
Weight	765 g
Dimensions (HxWxD)	62 x 105 x 208 mm
Magnification	6 x (optical), up to 30 x (combined by digital zoom)



**MINOX**

Great Price. Great Performance.



# Our quality seal.

Our MINOX products stand for durability, precision and brilliance. Every optic that leaves our Wetzlar forge meets our high quality standards. We also demonstrate this security with our 10-year Comfort Service.

The extended warranty is valid through online registration within 30 days after purchase or upon presentation of the purchase receipt.



# Our synergies.



Since February 2020, we have been operating from Isny in the Allgäu region of Germany, bringing us closer to the Blaser Group, to which we have belonged since 2013. The bundling of competencies and the intensive exchange enable completely new synergies.

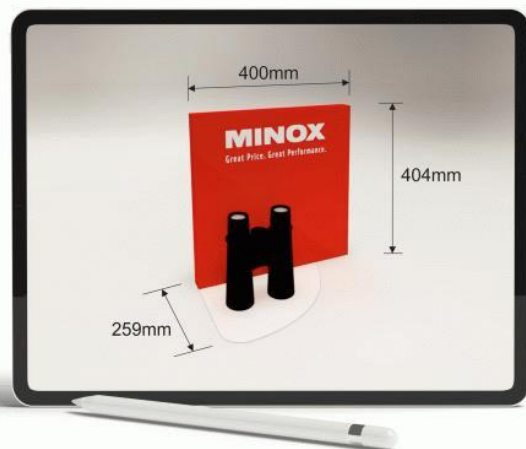

# Wir als Partner.

Um auch dir als Fachhändler ein umfassendes MINOX Erlebnis zu schaffen, bieten wir Partner Programme für unser Produktsortiment mit attraktiven Handelsmargen und Produktpräsentationen.

Werde jetzt ein Leistungsstarker MINOX Partner!





# Ehrliche Entscheidung !

Mit jeder MINOX Optik, die unser Haus verlässt, möchten wir dir als unseren Kunden ein zuverlässiges und hochwertiges Produkt zu einem fairen Preis an die Hand geben.

Damit uns das gelingt, bleiben wir im stetigen Dialog. Ein flexibler und kulanter Service ist dabei für uns selbstverständlich.

## MINOX GmbH

Optische und Feinmechanische Werke  
Ziegelstadel 1  
88316 Isny im Allgäu

E-Mail: [info@minox.com](mailto:info@minox.com)  
Telefon: +49 7562 98135 0



[www.minox.com](http://www.minox.com)